

MACHINERIES CATALOGUE

Version 23.1

2023

HEATTRANSFER.COM

Printing Machines and Supplies Division of Magic Trading Co. LLC.





Your Supplier of Printing Machineries & Supplies

For over 30 years, Magic Trading Company has been serving clients in the promotional gifts industry. Our dedication to creating and supplying our clients with the highest quality products & prints, has positioned us to be one of the Largest distributor of customized promotional gifts in the Middle East and Africa. We at Magic Trading, Strive ourselves to be your real one source for all your promotional gift and printing supply needs. We offer a wide range of products that are suitable for different methods of branding. Our skilled professionals use the latest design techniques and printing technologies to produce high quality prints and product customizations to meet our clients very unique and individual needs, In addition, We supply printing machineries and consumables to a wide range of entrepreneurs and printing companies.

HEATTRANSFER.COM
Printing Machines and Supplies Division of Magic Trading Co. LLC.

What we offer!

- ▶ Heat Press Machines
- ▶ Sublimation Printers & Inks
- ▶ UV Crystal Transferring Machine
- ▶ Cutting Plotters & Blades
- ▶ ID Card Printers & Accessories
- ▶ Foil Printers
- ▶ Button Badge Machines
- ▶ Shear Cutter & Corner Machines
- ▶ Acrylic Bending Machines
- ▶ Screen Printing Machines
- ▶ Laser Marking Machines
- ▶ Epoxy Doming materials
- ▶ Transfer Papers & Vinyls
- ▶ Sublimation Blank Products



We will make it
easier for you...
Convert your payments
into monthly installments.

**Pay In
3 Years
Instalment**

CATALOGUE INFORMATION

Colours of the actual products may slightly differ from the printed colours shown.
Some product sizes have indicated in cm / mm. Size may vary slightly from those indicated.
We make sure product details are provided, however due to volume of information
some data / info you need or looking for might have not been included.

Please visit us or contact us for more accurate specifications, sizes and design.

Offer applies on
all of Machines & Supplies.

(for UAE Customers only - conditions apply.)

INDEX

Machineries and Supplies

05

Heat Press Machines - 06

Cutting Plotters - 33

Sublimation Printers - 38

Inks - 48

UV Transfer Machine - 53

ID Card Printers - 54

Foil & Stamping Machines - 56

Button Badge Machines - 60

Shear Cutter & Corner Machine - 66

Screen Printing Machines - 70

Laser Cutting & Engraving Machines - 76

Acrylic Bender - 81

Transfer Paper & Vinyls

84

Large Selection of Transfer Papers - 85

Large Selection of Vinyl Materials - 94

Sublimation Blanks

103

Ceramic Mugs - 104

Ceramic Tiles - 110

Puzzles - 111

Photo Rock & Crystals - 112

Ceramic Ornaments - 114

Mouse Pads - 114

Tea Coasters - 115

Sublimation Bags - 116

Name Badges - 117

Lanyards - 121

Wall & Desk Sign Holder - 123



Machineries and Supplies

Large Selection of Machineries such as;
Heat Transfer Machines, Sublimation Printers,
Cutting Plotters, ID Card Printers, Foil Printers,
Button Badge Machines, Shear Cutter & Corner Machines,
Acrylic Benders, Screen Printing Machines,
Laser Cutting & Engraving Machines & more.



START WITH THE RIGHT EQUIPMENT

Take on new jobs with confidence by investing in quality equipment built to last. Whether you're just getting started or looking to grow, we have a variety of tools to help your business succeed.

THERE ARE **HEAT PRESSES** AND THEN THERE'S

HOTRONIX®

STAHL'S
Hotronix®



Made in USA

Born from the specific requirements of heat transfer materials, Hotronix® has been taking the guesswork out of heat applying since the 1980s. Now stronger and more advanced than ever, Hotronix® continues to engineer and produce the world's best-selling heat presses and accessories.

Proudly made in the USA, Hotronix® looks into the future of heat press innovation in an ever-changing industry to help your business become an efficient, profit-generating machine.



STAHL'S Hotronix®

STH-XF

FUSION IQ HEAT PRESS

The world's most advanced heat press just got smarter. Register your Fusion and access the Hotronix Online Portal to manage users, generate usage reports, and troubleshoot issues. Plus, a brand-new controller with a larger, higher resolution screen makes it easier than ever to modify settings and save recipes.

Features

- Online access to reporting, including total impressions, active/idle time, and average cycle time.
- Self-diagnostics help with troubleshooting and maintenance.
- Threadability™ makes it easy to load garments onto the lower platen and print front, back, and sides.
- Multiple time settings and Auto on/off setting.
- Quick change lower platens available for printing small items, hats, shoes, etc.
- Multi-level password settings & Available in eight languages.



Press Dimensions : 16 " x 20 " Platens (40 x 50 cm)

Temperature Range : 32°F - 430°F

Electrical Options : 120 V; 15 amps; 1800 W / 240 v; 15 amps; 3500 w

Product Dimensions : 32" x 18" x 20" (81 x 45 x 50 cm)

Actual Weight : 137 lbs (62 kg)



STH-XF-2

DUAL AIR FUSION IQ HEAT PRESS

Built for ultimate heat printing efficiency, the Dual Air Fusion IQ™ provides the functionality of two presses with dual 40 x 50 workstations. Program the press to preheat on station A and complete final application on station B, automatically adjusting time and pressure as it shuttles between workstations. It's a smooth, quiet, and effortless operation controlled by the push of a button and tap of the foot pedal. Simply power on and choose between dual or independent operation.

The Dual Air Fusion IQ™ also comes standard with a Laser Alignment System, assuring your job is on target every time. The laser system seamlessly integrates into each workstation and is controlled entirely through the touch screen.

Features

- Online access to reporting, including total impressions, active/idle time, and average cycle time.
- Self-diagnostics help with troubleshooting and maintenance.
- Auto Adjust Pressure™ with four different pressure and time settings that auto-adjust pressure for all recipes.
- Die pressure cast, corrosion-free base and top assemblies.
- Center-driven rodless transmission ensures smooth, quiet operation.
- Operates in full-auto, semi-auto, or manual modes.
- Threadability™ allows easy decorating of front, back, and sides of garments.

Press Dimensions : 2x - 16 " x 20 " Platens (2x - 40 x 50 cm)

Power Rating : 240 Volts; 15 amps; 3500 Watts

Product Dimensions : 38" x 38" x 26" (96.5 x 96.5 x 66 cm)

Actual Weight : 260 lbs (118 kgs) - including stand

*Requires air compressor (not included) with minimum 1 horse power and 5 gallon hold tank, 120 PSI. Uses 2.3 CFM. *



DOUBLE YOUR PRODUCTIVITY

The upper platen moves between heat printing stations, allowing operators to prepare garments on one station while the other is being pressed.





STAHL'S Hotronix®

STH-XRF-240D

AIR FUSION IQ HEAT PRESS

The world's most advanced heat press just got smarter. Register your Air Fusion and access the Hotronix Online Portal to manage users, generate usage reports, and troubleshoot issues. Plus, a brand-new controller with a larger, higher resolution screen makes it easier than ever to modify settings and save recipes.

Features

- Online access to reporting, including total impressions, active/idle time, and average cycle time.
- Exclusive Touch Screen Controller with new Multi-swipe gestures.
- Self-diagnostics help with troubleshooting and maintenance.
- Adjustable stand creates an ergonomic workspace for multiple users.
- Auto Adjust Pressure™ with four different pressure and time settings that auto-adjust pressure for all recipes.
- Die pressure cast 356 aluminum corrosion-free framework.
- Center-driven rodless transmission ensures smooth, quiet operation.
- Operates in full-auto, semi-auto, or manual modes.
- Threadability™ allows easy decorating of front, back, and sides of garments.
- Innovative EZ-On platen design eliminates the need for pillows or pads.

Press Dimensions : 16 " x 20 " Platens (40 x 50 cm)

Electrical Options : 120 V; 15 amps; 1800 W / 240 v; 15 amps; 3500 w

Product Dimensions : 40" x 32" x 57" (101.6 x 81 x 144 cm)

Actual Weight : 190 lbs (87 kg) - including stand

*Requires air compressor (not included) with minimum 1 horse power and 5 gallon hold tank, 120 PSI. Uses 2.3 CFM. *



STH-360C

360 IQ™ HAT PRESS™

HIGH PROFIT, HIGH IMPACT HATS. ONE MACHINE.

Successfully print on all sides of a hat without removing it from the press. The one-size-fits-all molded platen eliminates crease lines, and a heated lower platen makes it the perfect solution for applying emblems, appliqué, and patches. Best of all, it comes equipped with advanced IQ™ technology allowing you to track your business in real time.

Features

UPPER & LOWER HEAT - Heat from the lower platen makes application of dimensional emblems and embroidered or leather patches easy with dependable, quality results.

FULL PRINT RANGE - Create high-end retail looks in seconds by printing on the front, back & sides of a hat with one single platen. More placements = More Profits

NO HEAT PRESS CREASE - The uniquely designed molded lower platen forms to the shape of a hat, eliminating the heat press crease on decorated hats.

NO SCORCHING - Control the upper and lower platens independently. Reduce heat from the upper platen to protect heat sensitive hats from scorching.

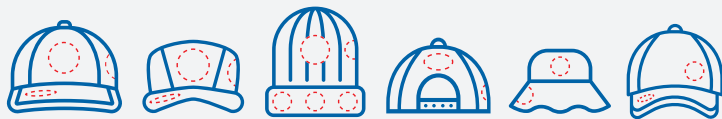

Any Placement from structured to unstructured -the molded lower platen lets you easily print unique placements not possible with other decorating methods.

Product Dimensions : 18" x 12" x 32" (45.7 x 30.4 x 81 cm)

Actual Weight : 44 lbs (20 kgs)



Start personalizing Sportballs



STAHL'S

STH-BP

SPORTS BALL HEAT PRESS

The Sports Ball Press is designed to easily customize or personalize inflatable sports balls. Balls can be customized for use as trophies, to commemorate a special event, or as a promotional giveaway.

Features

- Designed to decorate balls with a minimum of 20" circumference.
- Patented Magnetic Auto Open Feature & Assist Lock Down.
- Digital time, temperature, and pressure readouts.
- Adjustable ball cradle holds the sports ball
- Cast-in tubular heating element.

Types of ball that can be printed.



Maximum Print Size : 1.5" x 3" (4 x 7 cm)

Temperature Range : 205° - 420°F.

Product Dimensions : 24" x 10" x 22" (61 x 25.4 x 56 cm)

Actual Weight : 40 lbs (18 kg)



STH-STX

AUTO OPENING CLAM HEAT PRESS

Multi-task while avoiding over-application and ruined garments with this auto open clam heat press. Interchangeable platens allow you to heat print a variety of items of different shapes and sizes. Available in 2 sizes.

Features

- Patented Magnetic Auto Open Feature & Assist Lock Down.
- Platinum RTD heat sensor.
- Digital time, temperature, and pressure readouts
- Cast-in tubular heating element every 2" to ensure the absence of cold spots.
- Over-center pressure adjustment.
- 3/4" thick non-stick coated upper platen.

Item no. : STH-STX16

Press Dimensions : 16 " x 16 " Platens (40 x 40 cm)

Temperature Range : 205° - 420°F.

Electrical Options : 120 V; 15 amps; 1800 W / 240 V; 7.5 amps; 1800 W

Product Dimensions : 28" x 17" x 17" (71 x 43 x 43 cm)

Actual Weight : 77 lbs (35 kg)

Item no. : STH-STX20

Press Dimensions : 16 " x 20 " Platens (40 x 50 cm)

Temperature Range : 205° - 420°F.

Electrical Options : 120 V; 15 amps; 1800 W / 240 V; 7.5 amps; 1800 W

Product Dimensions : 29" x 17" x 17" (73 x 43 x 43 cm)

Actual Weight : 87 lbs (40 kg)



Optional Stand



STAHL'S

STH-STXC AUTO OPENING CAP PRESS

Ideal solution for heat applying logos on caps. Offer your customers full uniform customization with this automatically opening cap heat press. It's perfect for baseball and softball caps, fan wear, spirit wear, souvenirs, and more.

Features

- Designed to decorate caps of all sizes
- Patented Magnetic Auto Open Feature & Assist Lock Down.
- Digital time, temperature, and pressure readouts.
- Platinum RTD heat sensor.
- Cast-in tubular heating element every 2" to eliminate cold spots.
- Generates maximum pressure with less effort.
- Under-center pressure adjustment.



Press Dimensions : 6 " x 3.5 " Platens (15 x 9 cm)

Temperature Range : 205° - 420°F.

Electrical Options : 120 V; 4 amps; 500 W / 240 V; 2 amps; 500 W

Product Dimensions : 21" x 10" x 18" (53 x 25.4 x 46 cm)

Actual Weight : 30 lbs (13.6 kg)

 **Made in USA**



STH-STX6

AUTO OPENING CLAM HEAT PRESS

Ideal for smaller graphics, such as labels and left chest logos. Compact design makes travel easy. Saves space in your shop perfect for mobile heat printing opportunities.

Features

- Patented Magnetic Auto Open Feature & Assist Lock Down.
- Digital time, temperature, and pressure readouts.
- Platinum RTD heat sensor.
- Wide opening for easy layout.
- Cast-in tubular heating element every 2" to eliminate cold spots.
- Generates maximum pressure with less effort.
- Under-center pressure adjustment.

Press Dimensions : 6 " x 6 " Platens (15 x 15 cm)

Temperature Range : 205° - 420°F

Electrical Options : 120 V; 3 amps; 360 W / 240 V; 1.5 amps; 360 W

Product Dimensions : 21" x 10" x 18" (53 x 25.4 x 46 cm)

Actual Weight : 30 lbs (13.6 kg)



Maximum value heat press for start-up businesses.

Available in 2 sizes ; 15" x 15" & 16" x 20"



THE
MAXX[™]
PRESS

STH-MAXX

THE MAXX CLAM HEAT PRESS BY STAHL'S'

This affordable, simple-to-use clam heat press is perfect for start-ups and home-based businesses. Its light weight and space-saving clamshell design make it great for portable heat printing opportunities, as well.

Features

- Patented over-the-center pressure adjustment.
- Heat platen with non-stick coating.
- HRPO laser-quality steel framework.
- Smooth shock opening.
- Scratch-resistant, baked-on powder coat finish.

Item no. : STH-MAXX15

Press Dimensions : 15" x 15" (38 x 38 cm)

Electrical Options : 120 V; 15 amps; 1800 W / 240 V; 7.5 amps; 1800 W

Product Dimensions : 28" x 16" x 17" (71 x 41 x 43 cm)

Actual Weight : 65 lbs (30 kg)

Item no. : STH-MAXX20

Press Dimensions : 16" x 20" (40 x 50 cm)

Electrical Options : 120 V; 15 amps; 1800 W / 240 V; 7.5 amps; 1800 W

Product Dimensions : 29" x 17" x 17" (73 x 43 x 43 cm)

Actual Weight : 87 lbs (40 kg)





THE
MAXX[™]
PRESS

STH-MAXXC

THE MAXX CLAM HEAT PRESS BY STAHL'S'

Designed to decorate caps of all sizes, the MAXX cap heat press is great for anyone looking to get started decorating caps, or as a backup or travel heat press.

Item no. : STH-MAXXC

Press Dimensions : 6" x 3.5" Platens (15 x 9 cm)

Electrical Options : 120 V; 4 amps; 500 W / 240 V; 2 amps; 500 W

Product Dimensions : 21" x 10" x 18" (53 x 25.4 x 46 cm)

Actual Weight : 30 lbs (13.6 kg)



Made in USA



STH-BERRY

HOT BERRY HEAT PRESS MACHINE

Super compact and robust hobby transfer press. The Stahls' Hot Berry has a heat plate of 30 x 23 cm and is therefore perfect for starting textile printers and hobby purposes. This manual clam press is equipped with a digital timer for setting the correct temperature and pressure time.

Features

- Integrated timer. Enter the working time, and be alerted by a buzzer when the time is up.
- Pressure regulator. You don't have to worry about the pressure level, just press the button in the middle of the plate to keep the heat press at the right pressure level.
- Temperature control. Can be set to a temperature between 96 and 221°C.
- Trendy design, Modern look & high quality.
- Reliable and easy to use, space-saving and lightweight.



Press Dimensions : 12" x 10 " Platens (30 x 25 cm)

Temperature Range : adjustable up to 221 C°

Electrical Options : 240 Volt, 700 Watt, 10 Amp

Product Dimensions : 45 x 32 x 30 cm - closed state

Actual Weight : 32 lbs (14.5 kg)



Weeding Table

Increase productivity up to 80%.
Double order capacity.
Reduce Labor Costs.



MAKE MORE IN LESS TIME

TACKLE HARDER TO WEED MATERIALS

PROVEN TIME-SAVER

STH-WD-TBL

EZ Weeding Table

The EZ Weeding Table heats up your hot or warm peel heat transfer vinyl to make weeding easier and more efficient. A clamp-down feature provides the "extra hand" you need when weeding larger designs. Fits on most counter tops and production tables and folds for easy storage.



STAHL'S ACCESSORIES

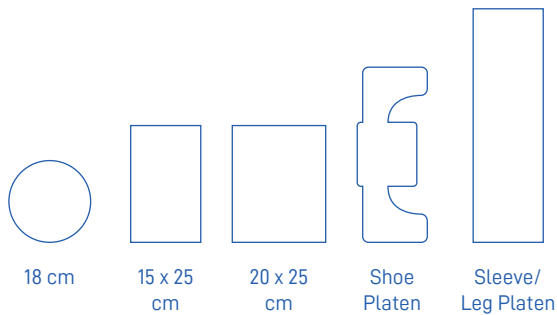

Interchangable Lower Platens

- Available Sizes :
- » 18 cm (Round)
 - » 15 cm x 25 cm
 - » 20 cm x 25 cm



Quick slip protectors

Fits perfectly over the lower platen, and makes it very easy to slide garments over the platen, as the non-stick coating reduces the amount friction between the garmet and the platen.

- Available Sizes :
- » 38 x 38 cm
 - » 40 x 40 cm
 - » 40 x 50 cm

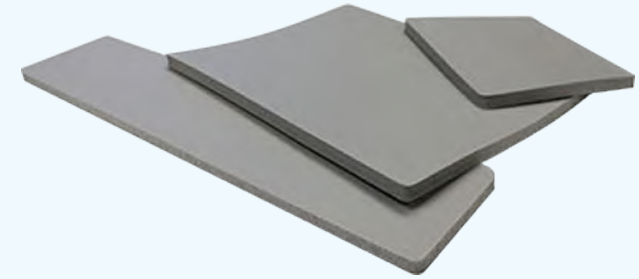

Print Perfect Pads

Print perfect pads have a similar purpose as heat printing pillows but works differently. Pillow allows the zippers and seams to depress into the pillow, while pads raise the printing area to work around these elements. They are also the recommended accessory for screen printed or digital transfers because they maintain even pressure. Print Perfect Pad 5" x 6" (13 x 15 cm)



Non stick coated pressure pad

For uniform distribution of pressure, when applying over items such as buttons, zippers, etc. and for applying close to V-necks. The pads are 2cm thick and contain inner foam, the outer pillow is made from a non-stick material.

- Available in following sizes :
- 25 x 25 cm for youth shirts
 - 15 x 20 cm for shorts and shoulders

STAHL'S ACCESSORIES

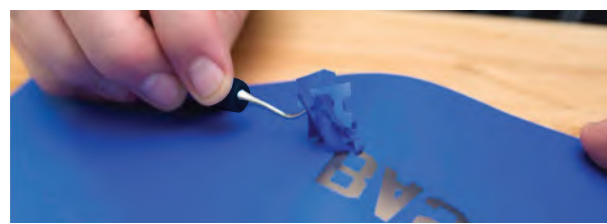

HTM-EZW
Weeder

An essential tool for easy weeding of vinyls.



TS-CH-B, TS-CH-M, TS-CH-S
Teflon Sheets

Teflon sheets are great for both fabric and heat press protection for any type of heat transfer. The Teflon protects the shirt and the press while still allowing heat to transfer the design. You can also use a Teflon sheet and a heat press to give direct plastisol prints a glossy look and feel.

Available in following sizes :
(B) 40 x 50 cm, (M) 40 x 40 cm, (S) 28 x 40 cm



240
Thermal Tape

Used to ensure that the transfer remains correctly positioned on the garment for application. Manufactured from heat resistant materials It is perfect use with mug transfers. Approx. 66m long.



AC
Airmec Air compressor

Model : CH50/210PL.
Power : 230 Volts, 1100 Watts - 1.5 HP
Pressure : 8 Bar
Made in Italy

Ideal Heat Press for your Start-up Business



MagicTransUSA
Superior Heat Transfer Solutions

HEAT PRESS MACHINE

Solid welded structure heat press machine with fully digital time and temperature control. Over the center pressure distribution.

HPM-01

Press Dimensions : 15" x 15" (38 x 38 cm)

Max Temperature : 221°C / 430°F.

Power Rating : 220 Volt, 1800 Watts

Product Dimensions : 66 x 40 x 83 cm

Item Weight : 85 lbs (39 kg)

HPM-02

Press Dimensions : 16" x 20" (40 x 50 cm)

Max Temperature : 221°C / 430°F.

Power Rating : 220 Volt, 1800 Watts

Product Dimensions : 80 x 42 x 93 cm

Item Weight : 115 lbs (52 kg)

HPM-04

2 IN 1 : HEAT PRESS MACHINE

Ideal choice for a start-up Business: with 3/4" thickness non-stick teflon coated upper heat platen. heat presses offer a stable and even heating working performance. it is a good choice for those customers looking for at stable quality heat press with competitive price. The full series machines can be used in digital direct-to-garment printing and heat transfer application business.

Flat Press Dimensions : 25.5 x 20.5 cm

Cap Press Dimensions : 9 x 16.5 cm

Max Temperature : 221°C / 430°F.

Power Rating : 220 Volt, 1800 Watts





HPM-08

LANYARD HEAT PRESS MACHINE

High quality manual heat press has been designed for the application of transfers to lanyards for customers with medium to high volume production. Double fully digital control panel for time and temperature accuracy and ease of operation.

Press Dimensions : 10" x 39" (25 x 100cm)

Max Temperature : 220°C / 430°F.

Power Rating : 220 Volt, 280 Watts

Time range: 0 - 999s

Gross Weight : 96 kg

Packing Size : 108 x 88 x 56 cm

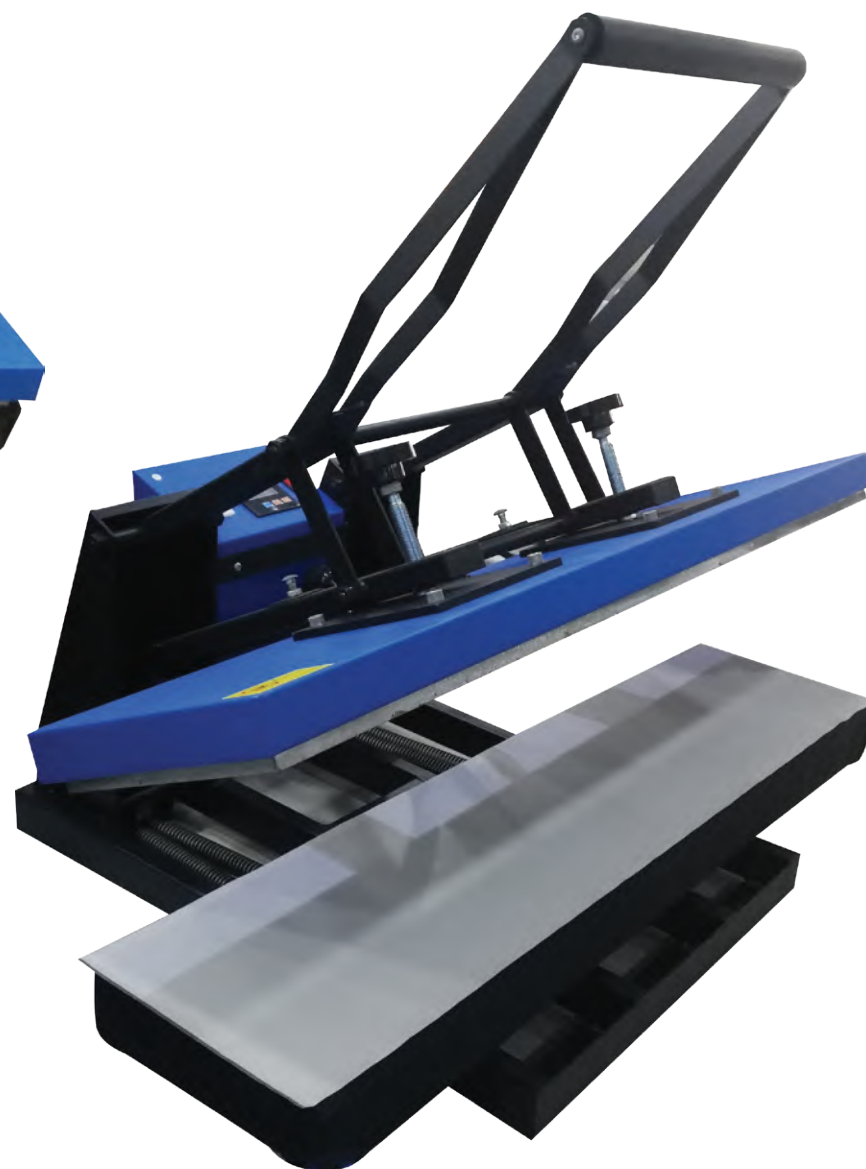



80x100 Heat Platen

683

LARGE FORMAT HEAT PRESS MACHINE

Easy-to-use heat press is perfect for medium to large businesses, Suitable for Tshirt printing, Sublimation Printing, Large size aluminum printing, Lanyard and cloth label printing etc. Sliding / draw table provides easy substrate placing.

Press Dimensions : 80 x 100 cm

Max Temperature : 204°C / 400°F.

Power Rating : 220 Volt, 6000 Watts

Product Dimensions : 114 x 112 x 60cm

Item Weight : 195 kg



LARGE FORMAT

DIGITAL MUG PRESS MACHINES



DHP-01

DIGITAL MUG PRESS MACHINE

Solid steel welded framework with Fully digital timer & temperature gauge, Casted iron cup holder housing with high quality heating element.

Press Dimensions : 7.5 - 9 cm (11 - 22 oz Mugs)

Max Temperature : 204°C / 400°F.

Power Rating : 220 Volt, 280 Watts

Packing Dimensions : 39 x 35 x 30 cm

Item Weight : 16.5 lbs (7.5 kg)

DHP-04

DIGITAL MUG PRESS MACHINE

Solid steel welded framework with Fully digital timer & temperature gauge, Casted iron cup holder housing with high quality heating element.

Press Dimensions : 7.5 - 16 cm (11 - 22 oz Mugs)

Temperature Range : 0 - 428°F

Power Rating : 220 Volt, 350 Watts

Packing Dimensions : 39 x 35 x 30 cm

Item Weight : 10 kg



Size : 10 oz
(for 6 , 10 oz mug)



Size : 11oz
(for 11, 15, 20 oz mug)



Size : 12 cm height
Conical Shape



Size : 16 cm height
Conical Shape



5 in 1

DIGITAL MUG PRESS MACHINE

comes with 5 separate press with its own digital display



655

DIGITAL MUG PRESS MACHINE

5 mug press for faster production time with 5 individual digital screen for temperature & modes. With an opening angle of 20°, Gas spring control.

Press Dimensions : 5x - 10 x 20 cm

Max Temperature : 225°C / 437°F

Power Rating : 220 Volt, 1750 Watts

Item Weight : 28.4 kg

4 in 1

DIGITAL MUG PRESS MACHINE

with Adjustable Heat Pads

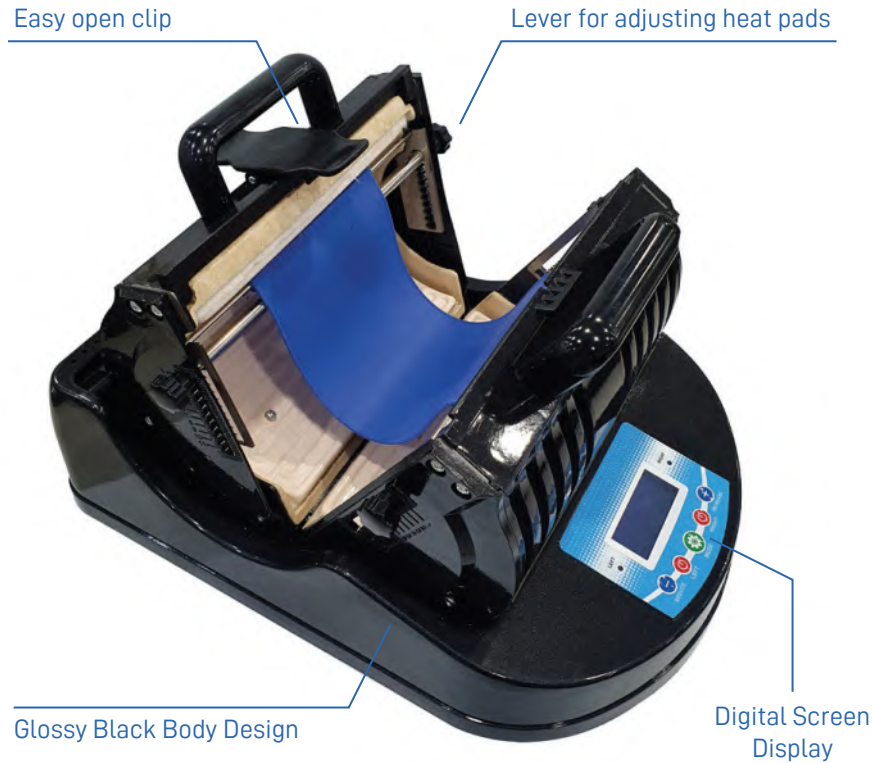

DHP-06

4 IN 1 : DIGITAL MUG PRESS MACHINE

This heat press machine adopts the design of ceramic heating plate and double circuit board, which greatly improves the transfer performance. With reliable and precise temperature control device, the stability has also been further improved. All the necessary accessories will be provided to bring you the beautiful graphics on different mugs!

Max Press Dimensions : 28 x 16cm

Max Temperature : 300°C / 572°F.

Power Rating : 220 Volt, 1300 Watts, 50 Hz

Packing Dimensions : 56 x 42 x 39.5 cm

Gross weight : 9.5 kg

4 in 1

DIGITAL MUG PRESS MACHINE

comes with 4 different heating pads

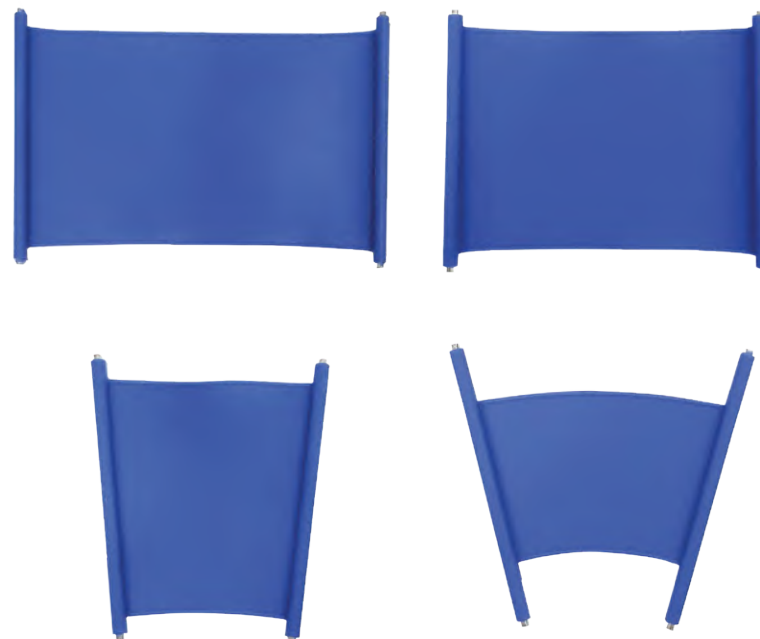

DHP-05

4 IN 1 : DIGITAL MUG PRESS MACHINE

This mug heat press machine for sublimation adopts the design of the ceramic heating plate and double circuit board, which significantly improves the transfer performance. With reliable & accurate temperature control device, the stability has also been further improved. All the necessary accessories will be provided to bring you the beautiful graphics on different cups!

Rated Power : 600W

Max Temperature : 400°C / 752 °F

Power Rating : 220 Volt, 1300 Watts, 50 Hz

Packing Dimensions : 56 x 42 x 39.5 cm

Package Size : 26.5 x 38 x 30 cm

11 in 1

MULTI-FUNCTION HEAT PRESS

includes a Set of Heat Pads

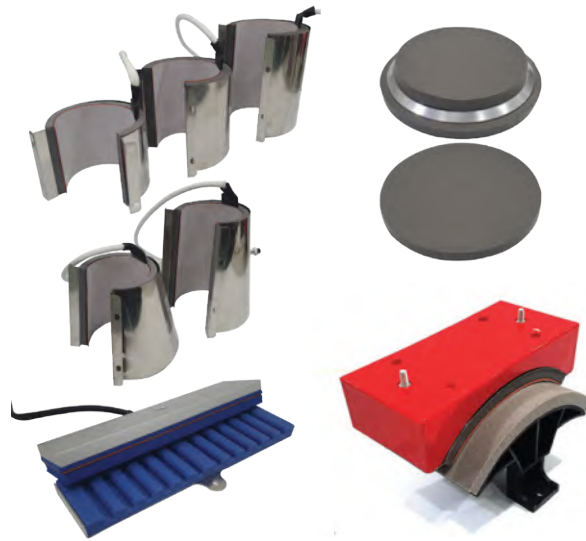

700

COMBO HEAT PRESS MACHINE

Combo heat press machine which can transfer cap, pen, mug, plate (various sizes available), t-shirt. The multi-purpose function of one machine greatly saves the production cost and reduces the production process, Meanwhile, it can meet customer demand which is equivalent to buying several machines.

Press Information : Can be used in 11 types of products

Max Temperature : 200°C / 390°F.

Power Rating : 220 Volt, 1000 Watts

Packing Dimensions : 44 x 35 x 38 cm

Packing Weight : 38 kg

Works with :

- › T-shirts
- › Caps
- › Pillows
- › Rock photo
- › Crystals
- › Aluminum Sheets
- › Ceramic Mugs
- › Ceramic Plates
- › Bottles
- › Pens



3D vacuum press is based on the newest sublimation technology.



HP-3D

3D VACUUM HEAT PRESS

The 3D vacuum heat transfer machine is multifunctional for both flat items and curved items, such as T-shirt, pillowcase, Tiles, mouse pad, glass, crystal, plate, mugs, Mobile/Tablet covers, etc.

Press Information : Can be used in 11 types of products

Control Mode : Automatic

Power Rating : 220 Volt, 2800 Watts

Packing Dimensions : 62 x 46 x 38 cm

Packing Weight : 25.5 kg





Silhouette

CAMEO 4

The Cameo 4 is a 12-inch width desktop cutting machine that lets you make precision cuts in vinyl, cardstock, fabric, and more.



VP-002

SILHOUETTE CAMEO 4

The Cameo 4 is a desktop cutting machine for the modern maker. With a built-in roll feeder and crosscutter, the Cameo is the ultimate vinyl cutter, allowing you to cut directly from a roll. It also has increased speed and power over previous Silhouette machines, a 3 mm clearance to cut thicker materials, and Automatic Tool Detection. Cut vinyl, cardstock, fabric, and more to create custom projects for home, school, or business.

Maximum cutting area : 30.5 cm x 61 cm with a cutting mat / 30.5 cm x 3m without a cutting mat

Media Width : Max. 118.11 mils (3 mm)

Max. cutting speed : 500 mm/s in all direction

Max. cutting force : 210 gf

Interface : USB 2.0 high speed / Bluetooth®

Blade type : Silhouette AutoBlade for Cameo® 4

Power source : 100-240 volts AC adapter

Product Dimensions : 57 cm x 19.5 cm x 17 cm

Item Weight : Approx. 4.7 kg

GRAPHTEC

PRECISION CUTTING SOLUTIONS

CE7000 SERIES



CE7000-60
24"



CE7000-40
15"



THROUGH CUT CHANNEL PER MODEL



DATA LINK BARCODE SYSTEM



USB SUPPORT FOR OFFLINE CUTTING



BUILT-IN CONVENIENT TOOL STORAGE



INCREASE PRODUCTION SPEED



XY SEGMENT AREA COMPENSATION

	CE7000-40	CE7000-60
Configuration	Grit Roller type	Grit Roller type
Drive Method	Digital Servo Drive	Digital Servo Drive
Max. cutting area :	15" x 164"	24" x 164"
Max. cutting speed :	24" per sec. at all direction	35" per sec. at 45° direction
Cutting force :	Max. 4.41N (450gf)	Max. 4.41N (450gf)
Power Rating :	120V AC, 240V AC, 50/60 Hz	120V AC, 240V AC, 50/60 Hz
External Dimensions : (WxDxH)	Approx. 30.4" x 11.5" x 12.3"	Approx. 39.6" x 23" x 43"
Item Weight :	28.7 lbs (13kg)	51 lbs (23 kg)

GRAPHTEC

VCP-004

GRAPHTEC CE7000-60 CUTTING PLOTTER + STAND

The new CE7000-60 Cutting Plotter is an easy to use, versatile, high quality, entry level desktop Cutting Plotter. Ideal for users based in a smaller work space, the Graphtec CE7000-60 Cutting Plotter automatically cuts a wide variety of media up to 600mm/24 inches wide.

Max. cutting area : 24" × 164"

Max. cutting speed : 35" per second at 45° direction

Cutting force : Max. 4.41N (450gf)

Power Rating : 100V to 120V AC, 200V to 240V AC, 50/60 Hz

Packing Dimensions : 109 x 99 x 66 cm

Item Weight : 25.5 kg

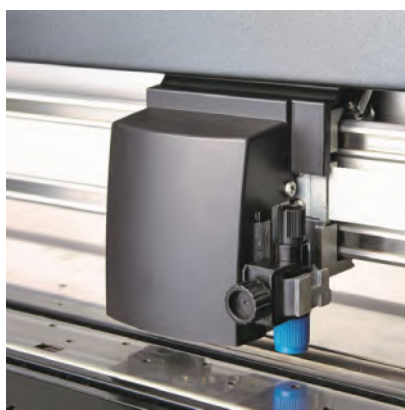

CAMM-1 GS-24 desktop cutter

Take your business into the future with the world's most reliable and versatile desktop cutter.



 Roland®

667-N

ROLAND CAMM-1 GS-24 CUTTING PLOTTER

The Roland CAMM-1 GS-24 desktop cutter is precision and efficiency to the max. With a completely redesigned cutting carriage and blade holder, the GS-24 offers great stability, up to 10x overlap cutting and down force of up to 350 grams so that you can cut like never before — even on thick, dense substrates.

Driving method : Digital control servo motor

Cutting method : Media-moving method

Maximum cutting area : : 22.9" x 984"

Cutting force : 30 - 350 gf

Loadable material width : 2" to 27.5"

Interface : USB 2.0 high speed

Power Input : AC 100 to 240 V ±10 % 50/60 Hz 1.7A

Power consumption : Approx. 30 W

Packing Dimensions : 97 x 45 x 39 cm

Item Weight : 18 kg

Cutting Plotter Replacement Blades



Replacement AutoBlade & Cutting Mat for Silhouette Cameo 3 and 4 Cutters.

VP-001-A : Cameo3 Blade - Automatic

VP-002-A : Cameo4 Blade - Automatic

VP-001-M : Cameo Blade - Manual

VP-001-DC : Deep Cut Blade



VCP-003-BL

Replacement Blade & Holder for Graphtec CE LITE-50



Replacement Blade & holder for Roland Cutting Plotter

667-J : Original Blade for Roland Plotter

667-C : Blade for Roland Plotter (China)

667-FB : Flock Cutting Blade

667-BH : Blade Holder

Sublimation Systems for Creative Entrepreneurs

Everything you need to make
and sell personalized products.

When you buy a Sawgrass printer, you're actually getting a business in a box. At no additional cost, you'll have access to a suite of resources that will help you build a successful product customization business. You'll be able to create locally, and sell globally.





SG500
A4 SAWGRASS PRINTER

The perfect printer for the hobbyist or moonlighter, the SG500 fits comfortably on a desktop, and prints on media up to 8.5" x 14" (22 x 36 cm). This allows you to apply custom artwork to a wide variety of popular, highmargin items, from mugs and coasters to phone cases and awards.



SG1000
A3 SAWGRASS PRINTER

The ideal printer for the growing business or ambitious entrepreneur, the SG1000 prints on media up to 11" x 17" (28 x 43 cm) with the standard tray. This is perfect for apparel, soft goods, and small or medium-sized photo panels.

Maximum Media Size	8.5" x 14" (215 x 355 mm) With Bypass Tray (Optional) : 8.5" x 51" (215 x 1295 mm)
Resolutions and Print Speeds	High Speed (600x600 dpi) - 15 seconds High Quality (600x600 dpi) - 29 seconds Advanced Photo (1200x600 dpi) - 48 seconds Ultra Fine Photo (4880x1200 dpi) - 6 minutes 40 seconds
Options and Ink	Standard Cartridges - C, M, Y, K (31ml)
Special Features	WiFi connectivity, 4880x1200 dpi resolution, Next-generation processor, Self-maintenance mode, Modulated Dot Technology for optimal image output
Physical Dimensions	15.75" x 17.25" x 8.5" (399 x 437 x 213 mm) With Bypass Tray, Option Tray, Extended Tray 15.75" x 28.5" x 23" (399 x 725 x 586 mm)

	11" x 17" (280 x 430 mm) With Bypass Tray (Optional) : 13" x 19" (330 x 482 mm)
	High Speed (600x600 dpi) - 15 seconds High Quality (600x600 dpi) - 29 seconds Advanced Photo (1200x600 dpi) - 48 seconds Ultra Fine Photo (4800x1200 dpi) - 6 minutes 40 seconds
	Standard Cartridges - C, M, Y (29ml), K (42ml)
	Desktop inkjet printers built specifically for digital decorating. Faster throughput for greater productivity and profit potential. Up to 4800 x 1200 dpi for dazzling HD photo-quality reproduction.
	20.8" x 20.0" x 8.3" (529 mm x 509 mm x 212.5 mm)

Efficient, compact and
precision technologies

EPSON[®]
EXCEED YOUR VISION



EP-SC-F100

EPSON - A4 DYE SUBLIMATION PRINTER

This is Epson's first A4 dye sublimation printer. With the footprint of an A4 desktop printer, the SC-F100 is perfect for producing promotional goods and personalised gifts such as mugs, key fobs, phone covers and other small merchandise items, when space is at premium. It also meets the needs of textile producers who want to create bespoke products such as, small bags, aprons, lanyards and cushions.

Epson's technologies are simple to use and highly intuitive. The compact SC-F100 features a tilting 2.4-inch screen, Wi-Fi connectivity and front-feeding, easy to change paper functionality (150 sheets).

Features

- Refillable ink solution 140ml ink bottles.
- Compact design With the footprint of an A4 desktop printer
- Connectivity Wi-Fi, Wi-Fi Direct, Ethernet, USB 2.0 connectivity
- End-to-end printing solution Inks, driver and paper, all designed to work in harmony.
- High-quality output PrecisionCore MicroTFP printhead for consistency and quality

Printing Method : PrecisionCore™ Micro TFP printhead

Printing Resolution : 600 x 1,200 DPI

Paper Formats : A4 (21.0 x 29.7 cm)

Product Dimensions : 375 x 347 x 187 mm (Width x Depth x Height)

Item Weight : 4.6 kg



Say goodbye to cartridges



EPSON®
EXCEED YOUR VISION

EP-L-805

EPSON - A4 SUBLIMATION PRINTER

Photo printer with Wi-Fi, delivering low-cost and Epson-quality 6-colour photo printing with the convenience of an integrated ultra-high-capacity ink tank. Able to print from phones and tablets, the L805 allows photographers to easily connect and print their photos.

Features

- Ultra-low-cost photos: Included inks can print up to 1,900 quality 10x15cm photos
- Epson-quality, reliable results: Micro Piezo technology and Epson genuine ink
- Boost productivity: Print a 10x15cm photo in as little as 12 seconds
- User friendly: Hassle-free with simple set-up and maintenance
- Flexible: Wi-Fi connectivity and easy mobile printing

Printing Method : Epson Micro Piezo™ print head

Printing Resolution : 5,760 x 1,440 DPI

Paper Formats : 16:9, 13 x 18cm, 10 x 15cm, 9 x 13cm, Legal, Letter, B5, A6, A5, A4

Product Dimensions : 54 x 28 x 18 cm

Item Weight : 8 kg



Ink Options

Sublimation Ink



Normal Ink



EP-L-L-1800

EPSON - A3 SUBLIMATION PRINTER

A compact six-colour A3+ printer for cost-conscious homes and offices, the L1800 prints photos in around 191 seconds¹. Its high-capacity ink tank system allows it to print 1,800 10x15cm photos² without a refill. With minimal intervention, it delivers cost-effective and hassle-free printing of photos and colour documents for homes, photographers and offices wanting to print in high volumes.

Features

- Ultra-low-cost: Purpose-built, refillable ink tank
- Photo printing: 6-colour A3+ printer
- Compact design: Small footprint ideal for home use
- User-friendly: Hassle-free with simple set-up

Printing Method : Epson Micro Piezo™ print head

Printing Resolution : 5,760 x 1,440 DPI

Paper Formats : A3+, A3, A4, A5, A6, B5, C4, C6, DL, Letter, Legal, 10x15cm, 13x18cm

Product Dimensions : 705 x 322 x 215 mm (Width x Depth x Height)

Item Weight : 12.5 kg

Ink Options

Sublimation Ink



Normal Ink



EPSON[®]
EXCEED YOUR VISION

Produce high-quality printed textiles and promotional goods with this low-maintenance dye-sublimation printer



Complete Epson solution

Easy user access and printhead maintenance minimise the need to call an engineer. This reduction in downtime and easy maintenance access keep your business running more efficiently. The enhanced specification of key parts increases product life and ROI

Ease of use

Quicker start-up from delivery. No special tools or specialist knowledge required. The out-of-the-box, easy start-up, gets businesses up and running as quickly as possible.

Complete package

We offer users the end-to-end production package, for their peace of mind and convenience. Includes: hardware, software, printhead, ink, sublimation papers, warranty, and an optional take-up reel to ensure everything works in harmony.

44-INCH DYE SUB PRINTER

EPSON SURECOLOR SC-F6300 (HDK)

The SureColor SC-F6300, 44-inch, dye-sublimation printer has been developed for textile producers, promotional goods businesses and photographic studios. It boasts a low TCO thanks to improved user productivity and reduced downtime.

Printing Method : PrecisionCore™ TFP print head

Printing Resolution : 720 x 1,440 DPI

Paper Formats : 44 " (111.8 cm) Roll

Product Dimensions : 1,608 x 1,128 x 917 mm (Width x Depth x Height)

Item Weight : 85 kg

**Expand
your business
offering**



24-INCH DYE SUB PRINTER

EPSON SURECOLOR PRINTER EP-F500

This is our first 24-inch, dye-sublimation printer. It was developed to help promotional houses, photo labs, clothing producers and copy shops increase customer choice through flexible, high-quality printing.

Printing Method : PrecisionCore™ TFP print head

Printing Resolution : 2,400 x 1,200 DPI

Paper Formats : 24 " (61.0 cm) Roll, A3 (29.7x42.0 cm), A4 (21.0x29.7 cm)

Product Dimensions : 970 x 811 x 245 mm (Width x Depth x Height)

Item Weight : 29 kg

OKI

PRINTING SOLUTIONS



Fast.
Powerful.
Compact.



C332DNW
A4 - OKI BASIC ENTRY PRINTER



C650DN
A4 - OKI PRINTER



PRO-8432WT
A3 - OKI PRINTER (White toner)

Printing Method	Digital 4 LED Full-color Electrophotographic	Digital 4 LED Full-color Electrophotographic	Digital 4 LED Full-color Electrophotographic
Printing Resolution	1200 x 600 dpi	600 x 600 dpi 1200 x 1200 dpi	600 x 600 dpi, 600 x 600 dpi (4 levels) 600 x 1200 dpi, Physical dot pitch: 600 dpi
Print Speed	A4 26 ppm color, 30 ppm mono	A4 35 ppm color, 35 ppm mono	Print Speed
Protocol	TCP/IP	TCP/IP	TCP/IP
Memory (Std./Max.)	1 GB	1 GB	256MB/768MB
Paper Size	A4, A5, B5, A6, Letter, Legal 13, Legal 13.5, Legal 14, Executive, 16K, Envelopes, Index Card (3" x 5") (75 x 125mm), Photo Size (4" x 6", 5" x 7") (100 x 150mm, 125 x 175mm), Statement, Folio, B6, B6 Half, 8.5" SQ	A4, A5, A6, B5, B6, B6 Half, B7, B8, Letter, Legal 13, Legal 13.5, Legal 14, Executive, Statement, 8.5" SQ, Folio, 16K, Index Card (3" x 5") (75 x 125mm), Photo Size (4" x 6", 5" x 7") (100 x 150mm, 125 x 175mm), Envelopes, Postcard	A3, A4, A5, A6, B4, B5, B6, B6 Half, Tabloid (11" x 17"), Letter, Legal 13, Legal 13.5, Legal 14, Executive, Statement, 8.5" SQ, Folio, 8K, 16K, Photo Size (4" x 6", 5" x 7"), Index Card (3" x 5") (75 x 125mm), Custom Size: Width 2.52-11.69" (64-297 mm) x Length 3.54-16.97" (90-431 mm).
Product Dimensions	410 x 504 x 242 mm	395 x 430 x 290 mm	449 x 552 x 360 mm
Weight	22.0 kg	Approx. 28.2 kg	37 kg
Power Consumption	Operating: Max. 1,170W / Ave. 540W	Operating: Max. 1,150W / Ave. 840W	Operating: Max. 1,400W / Ave. 700W
Duty Cycle	Recommended: 3,000 pages/month Maximum: 45,000 pages/month	Recommended: 8,000 pages/month Maximum: 100,000 pages/month	Recommended: 5,000 pages/month Maximum: 75,000 pages/month

INKS

Large Selection of Inks,
for your Sublimation Printers



Sawgrass Ink: World-class, Crafted by Experts

Never compromise on quality. That attitude has always driven the Sawgrass team. So, when it comes to sublimation ink, we don't settle for "good enough." We are dedicated to developing and producing ink as vibrant and extraordinary as the vision of our users.

Sublimation Ink for
Sawgrass SG500 & SG1000



Sublimation Ink for
Sawgrass SG400 & SG800





337

Sublimation Ink
Capacity : 100 ml

Available Colours :



Normal pigment ink
Capacity : 100 ml

Available Colours :



SUB-INK

Genuine Epson
Dye Sublimation Ink
Capacity : 140 ml

Available Colours :





RICOH

45ml - Ink cartridge for Ricoh SG3110dn

Available Colours :



OKI

Cartridge designed specifically for use with OKI Printing Solutions colour printers.



ECO-INK

ECO Solvent Ink for Sublimation Printer

Available Colours :



DTF

You may have heard of a new technology recently and its many terms such as, "DTF", "Direct to Film", "DTG Transfer", and more. Direct-to-Garment (DTG) Transfer is exactly what it sounds like. You print an artwork on a special film and transfer said film onto fabric or other textiles.



DTF-INK-W

White Ink for DTF Printer

Better Imprint clarity and enhanced vividness.
Water-based inks suitable for DTF.
1L / Bottle

DTF-INK

CMYK Ink for DTF Printer

Better Imprint clarity and enhanced vividness.
Water-based inks suitable for DTF.
1L / Bottle



DTF-PET

PET FILM

DTF transfer film is a semi-transparent film resistant to high temperatures for transfer on various media.

These films are different from those used in screen printing. DTF film is used with DTF ink and special DTF powder for heat transfer on various textiles, white, colored or black.

Product Size : 30 cm x 100 meters



DTF-PW

Hot Melt white powder for DTF Printer

Our DTF powder has a soft and stretchy feel and offers high adhesion. It will stick to the ink and not the film. The colors will turn out bright, vivid and waterproof and they are washable and durable

Works with most of DTF & DTG printers on the market and any PET film size.

UV CRYSTAL TRANSFERING MACHINE

NO HEAT REQUIRED

Simply Print crystal Inkjet film with your Inkjet printer then using UV Glue, join with the crystal and finally transfer by UV Machine



597

The advanced technology will allow us to transform your personal picture into a rich, full color transparency, sandwiched between two layers of sparkling crystal. It is 100% genuine crystal, featuring 360 degrees of transparency with all the elegance crystal brings.

Transfer Size : 40 x 36 cm

Voltage : 110V / 60 hz , 220V / 50 hz

Packing Size : 62 x 56 x 33 cm

Item Weight : 30 lbs (13.5 kg)



597-G Crystal UV Glue

Dimension : 12 x 22 cm
Volume : 100 ml



597-W A4 Jet Crystal Film (White)

597-F A4 Jet Crystal Film (Frosty)

597-C A4 Jet Crystal Film (Transparent)



DF-150

DIGITAL FACTOR ID CARD PRINTER

The Digital Factors DF150 card printer delivers the perfect mix of affordability, security and simplicity to get your ID card issuance program started. This economical ID card printer provides the right combination of technologies you need to efficiently print high-quality cards for less. Featuring rewritable printing, inline magnetic stripe encoding, a unique ultraviolet (UV) printing security feature and intuitive operation, the versatile DF150 card printer empowers you to meet a wide range of ID issuance application requirements.

digital factors

Entry-Level High Performance

Affordable cost, long-term value

Proven Reliability

Ultimate versatility and flexibility

Economical Security

Print technology : Direct-to-card dye-sublimation / resin thermal transfer

Print capabilities : One-sided, edge-to-edge printing.
Edge-to-edge rewritable, full-colour and monochrome printing.
Alphanumeric text, logo and digitized signatures; 1D/2D bar code images
Printer pooling / sharing.

Print resolution: 300 dots per inch, 256 shades per colour panel
High-quality mode : 300 x 600 dots per inch; enhanced text and graphic printing
300 x 1200 dots per inch; enhanced text and bar code printing

Print speed : Full-colour printing : up to 150 cards per hour, one-sided
Monochrome : up to 500 cards per hour, one-sided
Rewritable printing up to 14 seconds per card

Product dimensions : 39.1 x 17.5 x 22.4 cm



HDP-5000

HDP5000 ID CARD PRINTER

The Fargo HDP5000 dual sided id card printer is easy to operate and maintain. Cards, ribbons and lamination are cartridge-based, allowing for snap-in replacement and elimination of torn, wasted materials. It is one of the most reliable Smart card issuance systems / machines in the market. Superior print quality, higher reliability and durability, greater security, your photo ID cards will have all these qualities when you print and encode them with the affordable and versatile HDP5000 ID card printer and encoder. Everything looks better with High Definition Printing™. Colors are vibrant. Images are crisp and the best price.

Printing : Single or Dual Sided

Print Method : HDP Dye-Sublimation Resin Thermal Transfer

Resolution : 300 DPI

Colours : Up to 16.7 million 256 shades per pixel

Print Speed : Up to 24 sec. per card

Card Sizes : CR-80



FILM-HDP5000

HDP5000 Films

High Definition Printing ribbons & HDP Film combine to produce durable and tamper resistant cards with vibrant 300 dpi images



Blank ID Cards

- **HDP-5000-G**
(Gold Blank Card)
- **HDP-5000-N**
(Silver Blank Card)
- **HDP-5000-CR**
(White Blank Card)

Get vibrant,
High Definition cards from
the reliable and affordable
FARGO® HDP5000.

FOIL PRINTER MACHINES

Foil printing is a speciality printing process which uses heat, pressure and metallic paper (foil). This is used to create different shiny designs and graphics on various materials. This technique is an application of metallic or pigmented foil on to a solid surface by applying a heated die on to the foil.



DFP-AMD-8025 DIGITAL FLATBED FOIL PRINTER

Print Method : Thermal Printing

Max Printing Size : 57 x 250mm (W x L)

Printing Resolution : 300 DPI

Printing speed : 20-50mm/s

Power Rating : 110-240 AC, 150 W, 50/60hz

Packing Dimension : 61 x 61 x 40 cm

Weight : 28 kg

Print Materials such as; Papers, Cardboards, Stickers, Hardboards, Leather, PVC, PU Leather, Film, etc.



DFP-AMD-320 RIBBON FOIL PRINTER

Print Method : Thermal Printing

Max Printing Size : Width : 32mm / Lenght : Unlimited

Printing Resolution : 300 DPI

Feeding Size : Width : 40mm / Lenght : Unlimited

Power Rating : 110-240 AC, 150 W, 50/60hz

Packing Dimension : 29 x 29 x 28 cm

Packing Weight : 6kg

Print Materials such as; Satin, Polyester, Grosgrain, Nylon, etc, and Most kinds of ribbons.



DFP-AMD-55 DIGITAL PEN FOIL PRINTER

Print Method : Thermal Printing

Printing Resolution : 300 DPI

Printing diameter : 8mm - 20mm

Printing Lenght : 5mm - 55mm

Power Rating : 110-240 AC, 150 W, 50/60hz

Packing Dimension : 29 x 29 x 28 cm

Packing Weight : 8 kg

Print Materials such as; Ballpens, Pencils, Medical tubes, and most of the non-metal cylinder materials.



TWG

PNEUMATIC PLANE HOT STAMPING MACHINE

Foiling machines are designed to create a display that will capture the attention of people possessing the product. The foil film is positioned between the heated metal die and the material receiving the foil. The die presses the foil onto the material and the heat activates the adhesive. Under pressure, the foil fuses onto surface of the item and is released from the mylar carrier everywhere the raise image has pressed.

Features

- The crank design which has powerful stamping pressure and little consumption of air pressure.
- Worktable is adjustable in front-back, left-right direction and revolvable which ensures the quick and safe operation.
- Stamping pressure, temperature and time are adjustable.
- Automatic foils feeding and rolling with adjustable function.
- Height of the stamping head is adjustable.

Hot stamping size : 200 x 150mm

Power : 220V / 50Hz

Electro thermal Power : 1500W

Air Pressure : 0.6-0.8 Mpa

Stamping foil winding length : < 120 mm

Stamping speed : 1300 PCS/H

Machine Outline Dimensions : 700 x 620 x 1600 mm

Machine Weight : 210 kg

PSM-9080

DESKTOP PNEUMATIC HOT STAMPING MACHINE

This hot stamping machine is fit for stamping on the surface of plane objects with small area. With fast speed and low energy consumption. Mainly applied to the field of craft, fabric handbag, leather, paper and plastic.

Our hot foil presser PSM-9080 has a stable pressing force directly acted on by the pneumatic cylinder. The printing ribbon is transmitted by pneumatic mechanism. Its worktable allows optional adjustment. It is suitable for various stamping.

Features

- Stamping temperature adjustable range from room temperature to 400C.
- Stamping pressure is adjustable to install.
- Automatic rear-and-front worktable ensures safe and quick operation.
- Worktable capable of slight adjustment to rear-and-front, left-and-right and rotation.
- The height of the stamping head adjustable accordingly.
- Automatic foil feeding and rolling with adjustable function.

Hot stamping size : 90 x 80mm (3.5"x3.1")

Power : 220V / 50Hz

Electro thermal Power : 400W

Air Pressure : 0.5-0.7 Mpa

Stamping foil winding length : < 120 mm

Stamping speed : 800 PCS/H

Machine Outline Dimensions : 400 x 430 x 600 mm

Machine Weight : 45 kg





AMERICAN BUTTON BADGE MACHINE

404

56mm ROUND MOLD AMERICAN MANUAL BUTTON BADGE MACHINE

Mold Size : 56 mm

Packing Dimension : 11 x 27 x 24 cm

Weight : 4.2 kg

402

44mm ROUND MOLD AMERICAN MANUAL BUTTON BADGE MACHINE

Mold Size : 44 mm

Packing Dimension : 11 x 27 x 24 cm

Weight : 4 kg

400

32mm ROUND MOLD AMERICAN MANUAL BUTTON BADGE MACHINE

Mold Size : 32 mm

Packing Dimension : 11 x 27 x 24 cm

Weight : 3.8 kg

7 in 1

BUTTON BADGE MACHINE

One machine, Makes 7 Products



407

**7-in-1 BUTTON
BADGE MAKER**

Easily create unique and personalized buttons in bulk.
A way to express your creativity.
Create paper and film covered, as well as fabric-covered buttons.
Quickly change molds to create buttons of other shapes and sizes.
A lighter and more powerful button badge maker.



75mm
Badge



56mm
Badge



44mm
Badge



32mm
Badge



56mm
Magnet



44mm
Magnet



44mm
Keychain

optional
molds



406-M
Hexagon Mold

Mold for 65 x 60 mm - Hexagon

optional
molds



399-M
Oval Mold

Mold for 45 x 70 mm - Oval



Includes a Basic manual circle cutter
Made from transparent acrylic material.

640

PHOTO & CLOCK BUTTON BADGE MACHINE

This machine can make photo frame, photo coin saving box and clock, Fast swing track operation, Strong composite aluminum dies for long-term use.



Ceramic Plate



Photo Coin Bank



Photo Clock



Photo Frame



641

HOLE PUNCHING MACHINE

Machine that makes a hole on the 158mm table clock button badge. Product Dimension : 25 x 30 x 13 cm, Actual weight : 4.5 kg.



This machine makes the center hole on these products.



Weight : 4 kg
Dimension :
19 x 13 x 14 cm



Weight : 4.5 kg
Dimension :
26 x 23 x 19 cm



Weight : 4.5 kg
Dimension :
26 x 23 x 19 cm



Weight : 5 kg
Dimension :
26 x 23 x 19 cm



Weight : 5 kg
Dimension :
26 x 23 x 19 cm



BUTTON BADGE SINGLE CUTTER

Make cutting out multiple circles a breeze with our heavy duty cutter. This cutter is perfect for serious badge makers. Highly recommended for larger volumes of badge making.

Cutter Size	Item Number
32 mm Cutter	136-32
44 mm Cutter	136-44
56 mm Cutter	136-56
75 mm Cutter	136-75
Oval Size Cutter	143-SC



BUTTON BADGES ACCESSORIES



136
Manual Circle Cutter
 Cutting Size : 44mm up to 158mm



642
158mm Button Clock
 Basic Analog Clock



643
158mm Photo Stander
 Backside with Stand



644
158mm Button Coin Box
 Aluminum and Plastic Material



136
Manual Circle Cutter
 Cutting Size : 44mm up to 158mm



BB-75-3D (75 mm)
BB-56-3D (56 mm)
BB-44-3D (44 mm)
BB-32-3D (32 mm)
640-3DF (158 mm)
3D Effect Film for Badges



157-F
Frosted Foldable Plastic Display Stand
 Folded Size : 10.5 x 18 cm

BUTTON BADGES ACCESSORIES



401
32mm Metal Button Badges



403
44mm Metal Button Badges



405
56mm Metal Button Badges



625
75mm Metal Button Badges



406
Hexagon Metal Button Badges



625-P
75mm Plastic Button Badges



623-P
44mm Plastic Button Badges



622-P
32mm Plastic Button Badges



629-M (Metal) / 629-P (Plastic)
Oval Shaped Button Badges



630
44 mm Keychain Button Badge
with Keychain ring attachment



405-N
56mm Button Badge with Bottle Opener
American Baadge with Bottle Opener.
(Optional Key Ring Attachment)



627 (56mm)
626 (44mm)
Magnetic Button Badges
Available in 2 Sizes
Backside with Magnet





**R3 - Small
Corner Cut**



**R5 - Large
Corner Cut**

**618-M-CH
CORNER MOLD**

Cutting size : Available in R3 & R5
Max Cut Thickness : up to 1.0mm thickness
Product Dimension : 17.5 x 8.5 x 3 cm

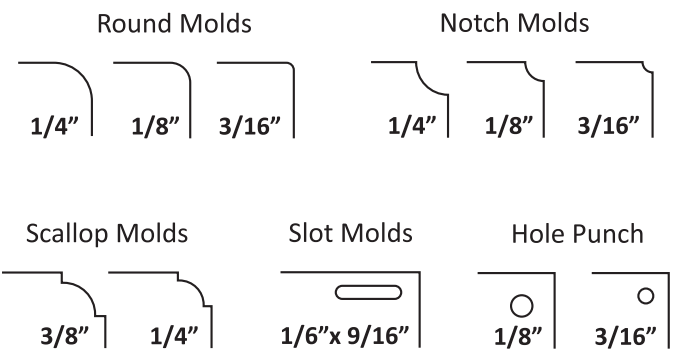
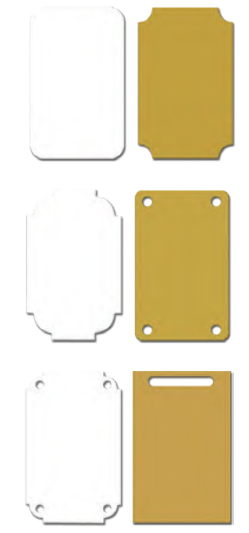
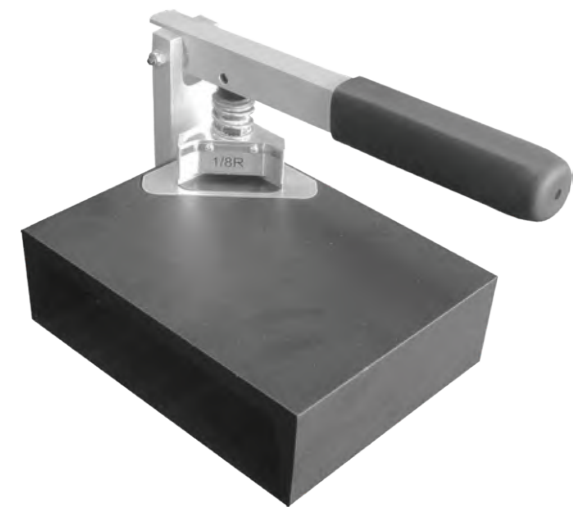

**618
CORNER CUTTING MACHINE**

Cutting size : check above details
Max Cut Thickness : Steel : 0.3 mm, Brass : 0.5 mm, Aluminum : 1.00 mm, Plastic : 1.6 mm
Product Dimension : 28 x 21 x 16 cm
Weight : 5 lbs (2.3 kg)



613

12" SHEAR CUTTING MACHINE

Cutting size : up to 12" wide

Max Cut Thickness : up to 1.6mm thickness

Product Dimension : 38 x 26 x 52 cm



616

12" SHEAR CUTTING MACHINE

A low cost high quality shear assures burr-free plates over the full 12 inch cut. Hardened tool steel blades are removable for sharpening and cuts accurately on steel, brass, and aluminum materials. an adjustable stop can be set for repetitive plates. The shear is designed on the same principle as the large commercial shears, with the blade closing in a guillotine fashion which give greater support and helps to prevent movement of the plate during the shearing process.

Cutting size : up to 12" wide

Max Cut Thickness : up to 1.6mm thickness

Product Dimension : 35 x 30 x 20 cm

Weight : 30 lbs (13.6 kg)

Epoxy Doming

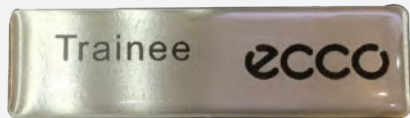

Epoxy doming is the effect of placing epoxy on the surface of most anything that has an edge, like labels, cut metal and more, when the epoxy hardens it leaves a clear glass like dome covering the item.

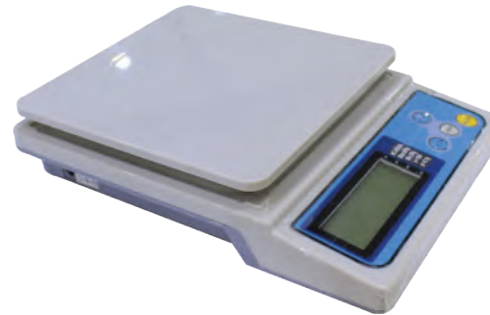

100

Digital Scale

Auto Calibration, Auto backlight & Battery indication.
g/t/oz/lb Conversion, Power : 6x AA Size Battery or AD/DC Adaptor.



614

Air Release Gun

Electronic Instant Ignition system
Max. Temp : 1,300°C or 2,400°F
Adjustable Flame, Refillable ; 24g Butane Fuel tank



102

Epoxy Sticker (A4 Size)

PVC Stickers for Inkjet Printers



615

Dispensing Bottles

R-101 : Hard Epoxy Resin
H-101 : Hard Epoxy Hardener

R-103 : Flexible Epoxy Resin
H-103 : Flexible Epoxy Hardener



EP-H-323

Hard Epoxy Set (Resin & Hardener)

Capacity 1095 ml and 400ml
 Size: 81.5 x 80.5 x 220 mm and 62.5 x 62.5 x 165 mm
 Colors: Transparent Clear

EP-F-315

Flexible Epoxy Set (Resin & Hardener)

Capacity 1095 ml and 400ml
 Size: 81.5 x 80.5 x 220 mm and 62.5 x 62.5 x 165 mm
 Colors: Transparent Clear



V1-44

AMERICAN SCREEN PRINTING MACHINE 4 STATION / 4 COLOURS

Vastex engineered the V1-44 manual garment printer to meet the needs of the commercial grade screen printer. The V1-44 uses the industry's most unique floating head design. Accurate registration can be achieved without the high cost associated with machines of this capacity.

Maximum Screen Width : 23" (58.5 cm)

Max. Screen Weight : 5.5 lbs (2.5 kg)

Product Dimension : 241 diameter x 98 height (cm)

Weight : 256 lbs (116 kg)

Micro-registration : Wrenchless

Head Lifting : Extension Spring



VI-66

AMERICAN SCREEN PRINTING MACHINE 6 STATION / 6 COLOURS

Features all-heads-down printing, rubber-coated steel platens, and a floating head design with tool-free micro-registration and six-way head leveling to deliver multicolor registration accuracy. A redesigned rotor hub increases the rigidity of the platens and arms while allowing for more platens including oversized and heavyweight vacuum platens used for transfers, signs, & flat stock.

Maximum Screen Width : 23" (58.5 cm)

Max. Screen Weight : 5.5 lbs (2.5 kg)

Product Dimension : 280 diameter x 98 height (cm)

Weight : 369 lbs (167.4 kg)

Micro-registration : Wrenchless

Head Lifting : Extension Spring





V1-SD

VASTEX HEATER (ENTRY LEVEL FLASH CURE UNIT)

High wattage and close coil density heater, for greater heater surface consistency. Powerful heaters with built-in heat shields allow Vastex flashes to be set closer to your garment, which increases efficiency and productivity.

- 1,625 Watt, 120V or 240V, IR Heater
- On/off power switch
- Heavy duty side handles
- Head leveler to adjust the heater parallel to the pallet
- Heat shields for even heater temperature
- International power cords available

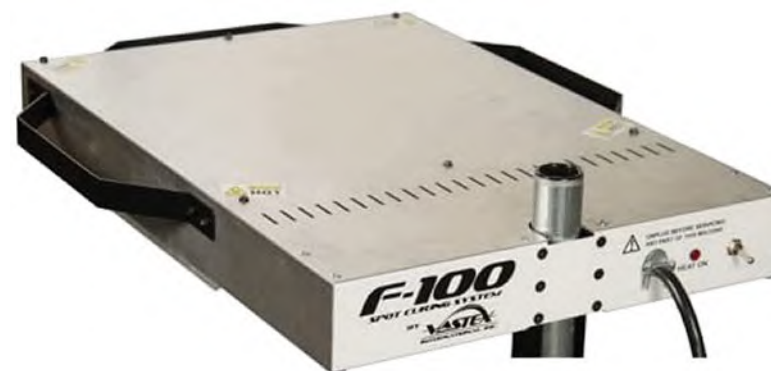



687-S SCREEN PRINTING MACHINE

Flat bed manual screen printing table with adjustable base plate. Suitable for single and multi color prints on to substrates such as wood, glass, cardboard, paper, metal plates, plastic or fabric etc. Adjustable larger bed size of 40 x 30cm allows fine adjustments for greater registration on multiple prints. Adjustable rear counterweight allows different sized screen frames to be used. Easy height adjustment of frame holding arm allows printing objects up to 12cm in depth.

Screen Size : 40 x 30 cm

Product Dimension : 55 x 40 x 15cm

Weight : 18.7 lbs (8.5 kg)

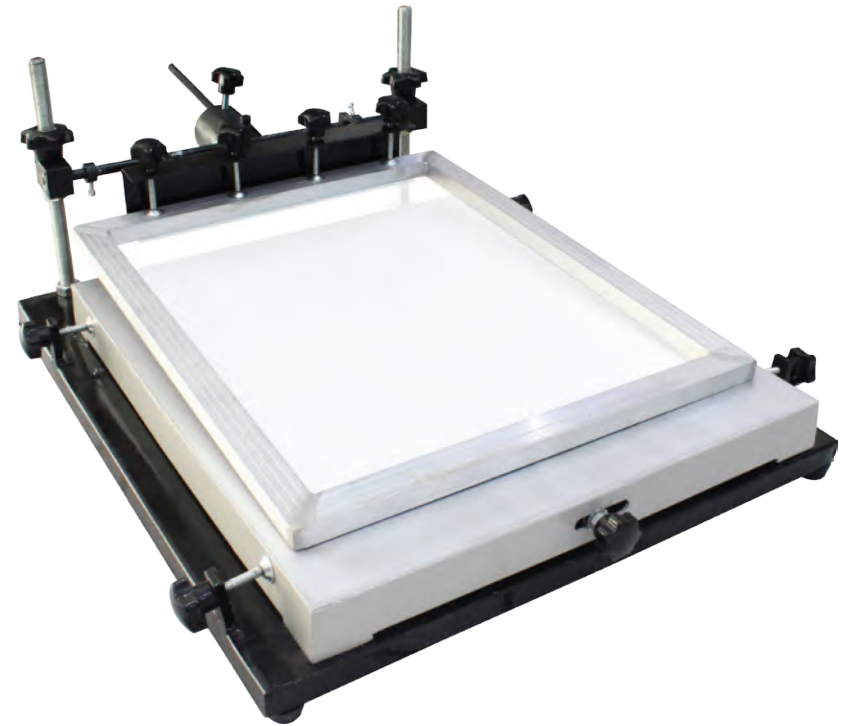

687-B SCREEN PRINTING MACHINE

Flat bed manual screen printing table with adjustable base plate. Suitable for single and multi color prints on to substrates such as wood, glass, cardboard, paper, metal plates, plastic or fabric etc. Adjustable larger bed size of 60 x 50cm allows fine adjustments for greater registration on multiple prints. Adjustable rear counterweight allows different sized screen frames to be used. Easy height adjustment of frame holding arm allows printing objects up to 12cm in depth.

Screen Size : 60 x 50 cm

Product Dimension : 72 x 60 x 20cm

Weight : 49.7 lbs (22.5 kg)



690

CURVED SCREEN PRINTING MACHINE

Solid metal structure screen printing machine that specialize on curved or rounded objects such as; mugs, pens & other cylinder materials.

Screen Size : 40 x 20 cm

Product Dimension : 54 x 40 x 38 cm

Weight : 78 lbs (35.5 kg)



SP-002

SCREEN PRINTING MACHINE WITH ADJUSTABLE PALLET

The Pallet is adjustable. Forward, backward and from left to right. Screen Clamp can be moved up and down. It adopts full metal Structure with parts of stainless steel material.

Suitable for screen frame within 4.5 cm thickness

Packing Dimension : 63 x 52.5 x 28 cm

Packing Weight : 14.3 kg

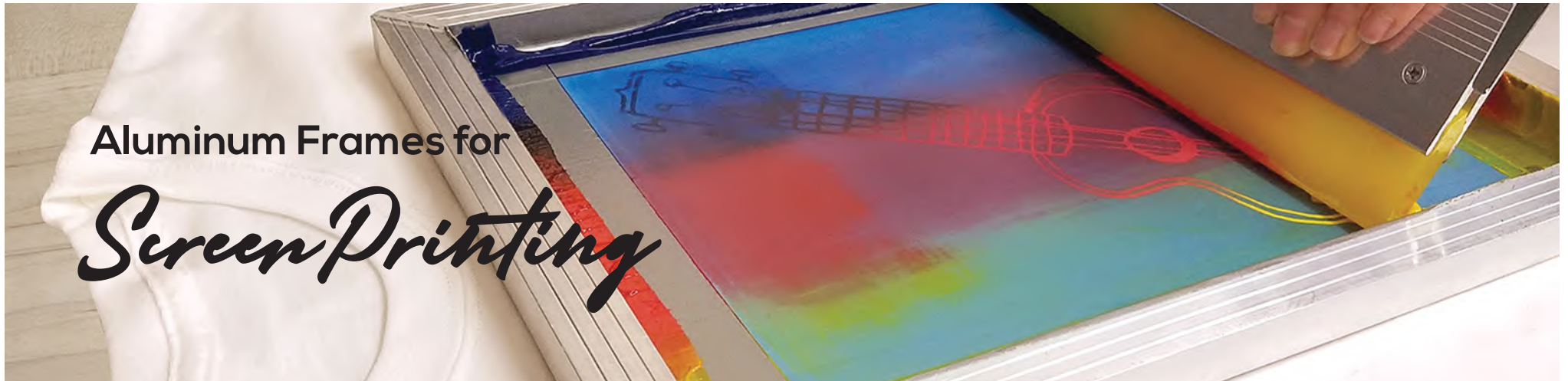

Aluminum Frames for
Screen Printing



SP-ALU-FR

Aluminum Frame with Mesh

Frame Size : 40 x 50 cm
60 Mesh (SP-ALU-FR-1) / 120 Mesh (SP-ALU-FR-2)



687-FS

Aluminum Frame

Frame Size : 30 x 40 cm



FL-011
SPLIT MODEL LASER MARKING MACHINE

Intelligent mark positioning laser marking machine with cyclops system is one new technology for laser marking machine. The image from the camera can be displayed on laser marking software in the computer.

Wave length : 1064 nm
Marking Area : 100 x 100 mm
Linear Speed : 7000mm/s
Linear Speed : 7000mm/s



FL-03
ENCLOSED MODEL LASER MARKING MACHINE

This Laser machine enables you to quickly and permanently mark or etch metals, tools, metal parts, jewelry, bar codes, serial numbers, industrial polymers, etc.

Wave length : 1064 nm
Marking Area : 100 x 100 mm
Marking Depth : 0.2 mm
Linear Speed : 7000mm/s



Laptop included

FL-01

LASER MARKING MACHINE

Laser marking machines to make non-contact permanent markings in a variety of metal and non-metal material surface such as; logos, coding, text or even images which is simple, fast and exquisite, highly efficiency and permanent security. It could improve the product phase and enhance the brand by marking fine lines, which is the best way to identify the product.

Wave Length	1064 nm	Minimum Line Width	0.001 mm
Marking Area	110 mm x 110 mm	Minimum Character Size	0.15 mm
Marking Depth	0.2mm	Cooling	Air Cooling
Linear speed	7000mm / sec.	Working Voltage	220V / 50Hz



DW-210 Fume extractor

Air inlet interface : **75mm / 50mm**
Input voltage : **AC110V/220V**
Power : **210W**
Filtering effect : **0.3μm 99.97%**
Noise : **<55dB**
Flow : **330m³/h**
Overall dimension : **425 x 250 x 410cm**
Weight : **13.00 Kg**
Application: Small fiber marker with working size
100 x 100mm and 150 x 150mm



Available in



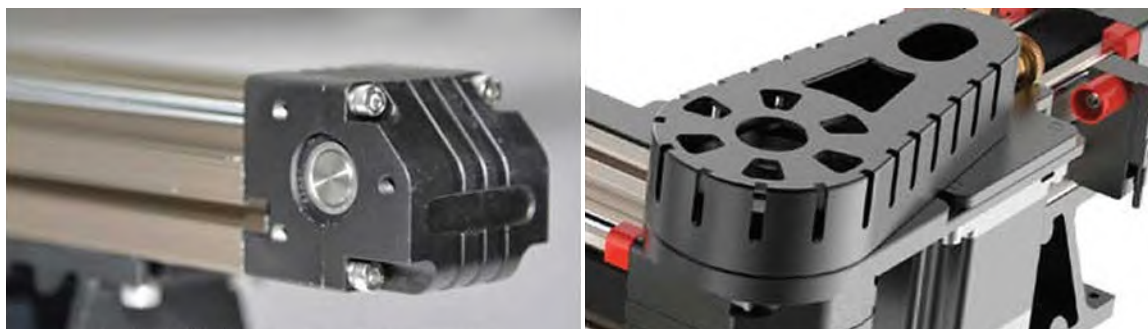

645-1390

LASER CUTTING MACHINE

High Speed Mute - silent slider to reduce the resistance of the laser head and the plotter during the movement, making the laser machine work more smoothly. It can adapt to the precise operation of the heavy-duty laser machine and ensure that the laser machine runs efficiently and stably for a long time.

Easy to Adjust - The adjustable aluminum alloy mirror bracket can adjust the laser angle arbitrarily, the structure is simple and convenient to operate, the laser device is stable, and the maintenance cost is low. The outer surface is oxidized beautifully, with high temperature resistance and wear resistance.

Stable Durable - The X / Y Axis uses high-precision belt-driven motor to improve response speed and cutting accuracy. The dual coaxial power transmission is more stable, reducing the inertia error, improving the engraving precision and life of the laser machine.

Working area	1300mm x 900mm
Laser power	100 W
Laser type	CO2 sealed laser tube
Cutting speed	0-24000mm/min
Engraving speed	0-60000mm/min
Resetting positioning accuracy	±00.05mm
Operating temperature	0-45°C
Min.shaping character	English 1.0x1.0mm
Support graphic format	PLT AL DXF BMP DST
Control system	DSP control RUIDA system
Cooling mode	Water-cooling and protection system
Working voltage	110V-220V/50~60HZ
Driving system	Stepper motor (Option servo motor)
Actual Dimension	194 x 140 x 98 cm

645-3040

LASER ENGRAVING MACHINE

- The working platform is transparent, the length of the engraving material is unlimited
- Import liner high speed side rail, which can ensure high precision, high speed and super long operation life.
- Newly professional software and motherboard, powerful, and can continuously work under high temperature, support CorelDRAW output.

Working area	300mm x 400mm
Rotary	Optional
Laser power	40 W
Laser type	CO2 laser tube
Engraving speed	10-500mm/s
Resolution ratio	0.0125 mm
Interface	USB
Minimum shaping character	Letter:0.01mm
Support graphic format	BMP, PLT, DXF, AI, JPG.
Software	AI, CorelDraw
Cooling mode	Circulation water cooling
Working voltage	AC220V/50HZ or 110V/60HZ
Packing Dimension	93 x 78 x 59cm
Packing Weight	75 Kg



645-6040

LASER ENGRAVING & CUTTING MACHINE

High performance CO2 laser cutting and engraving machine with a table. A compact model with a wide working area of 60 x 40 cm. 60w glass laser tube, LCD monitor control system and high quality CO2 laser source provide high precision and speed. Performance is stable and durable. Aluminum alloy working table helps in engraving works and honey comb table for cutting jobs. Machine is packed with software, industrial chiller and exhaust system.



Working Area	400 x 600 mm
Laser tube	CO2 Laser Tube
Engraving speed	0-30000mm/min
Cutting speed	0-3600mm/min
Resolution ratio	0.005mm

Scanning Precision	1000 DPI
Working Voltage	220V / 50Hz
Dimension	177 x 87 x 77mm
Weight	175 kgs



DW-12-2.2 Fume extractor

Flow : **350m³/h**
 Noise : **< 68dB**
 Inner installed Exhaust fan Power : **750W**
 Whole power : **1.2KW**
 Voltage : **AC110V / AC220V**
 Weight : **103kg**
 Size : **530 x 590 x 1090mm**
 Filter : Bag x2+ Carbon fiber x1 +Electric modul x1+
 UV x3+Ion x1+Activated carbon x1+750W inner installed
 exhaust fan + soft pipe Dia 150/200mm



Acrylic

BENDING MACHINE

AB-01

ACRYLIC BENDING MACHINE

A Revolutionary tool set for bending plexiglass, the easiest way of making 3D Acrylic Letters.

Bending Size : Round - 100 x 50mm / Sharp - 100 x 2.5mm
Power : Round Bender - 60 W / Sharp Bender - 39 W
Packing Dimension : 1 Set (31 x 16.5 x 6 cm)
Weight : 1.91 lbs (0.87 kg)





AB-02 / AB-03

ACRYLIC HEATING BENDING MACHINE

- ▶ Unique design, small size, compact structure and beautiful appearance.
- ▶ The main body is made of special aluminum profiles provides even heating and adjustable temperature.
- ▶ Lightweight and practical, space saving, circulating cooling water system on both sides of the heating pipe.
- ▶ Acrylic hot bending machine, compact structure, reasonable design, can be combined with workbench into a hot bending machine, can also be used alone, does not take up space.
- ▶ Wide range of suitable materials: such as acrylic, organic boards, PVC materials and various thermoplastic materials.

Size : **AB-02 (60 cm) / AB-03 (120 cm)**

Power : **AB-02 (220V / 800W) / AB-03 (220V / 1200W)**

Safety precautions:

- Product heating produces high temperature, heating components should avoid contact with human skin.
- Please pay attention to the use of the environment, away from inflammable and explosive goods.
- If you don't use it for a long time, please cut off the power in time.

DRY TYPE ACRYLIC BENDER



AB-04

DRY TYPE ACRYLIC BENDER

Dry type acrylic bending machine / heater is a new type of linear acrylic bending heater. It adopt thermal insulation, space insulation, shell cooling and automatic air-cooled and other technologies. It doesn't need water cooling and it can be operated after plugged in. It is easy to use, environmentally friendly energy-saving, it can work 24 hours a day without maintenance. It can be used alone or with the rack and backup plate. It is a really maintenance free acrylic bending machine.

Heating Width : 1220mm (48 ")

Power Rating : 220V, 500W

Packing Dimensions : 1350 x 280 x 160 mm



Transfer Paper and Vinyls

Specialty paper that transfers printed designs to garments and other products when heat is applied.

The process involves printing a design onto a sheet of heat transfer paper using an inkjet or laser printer, then applying heat using a heat press machines to produce a product with your design on it.

We offer a large selection of transfer papers & vinyls depending on your needs.

Coated Paper for Sublimation Printing

Paper is a relevant factor in the sublimation process because it influences the final quality of the transferred image. Our papers are characterized by optimum parameters and they are made especially for sublimation.



359 (A3 Size) / 294 (A4 Size)

COATED PAPER FOR DYE SUBLIMATION PRINTING

Transfer to materials such as : Coated ceramic mugs, plates & tiles
Aluminum sheets, Photo Rocks & Crystals, Mousepads.



HTP-A3 (A3 Size) / HTP-A4 (A4 Size)

COATED PAPER FOR SUBLIMATION BY SAWGRASS or RICOH PRINTER

Transfer to materials such as : Coated ceramic mugs, plates & tiles
Aluminum sheets, Photo Rocks & Crystals, Mousepads.



Distributor of Texprint from beaver paper

World's Best Sublimation Paper



TP-ELITE-HS

for High Speed Textile Printer

TexPrint Elite sublimation paper is designed for high-speed applications. This middleweight paper is suitable for all around everyday use. This paper is textile grade that can be used for both normal and high-speed production. This paper's design gives easy handling with excellent color transfer while reducing cockling.

Size : 1.62 m x 130 m (162 cm x 1300 cm)

Paper weight : 92 gsm



TP-XP-HR

for General Purpose

TexPrint XPHR is a simpler way of getting things done. This multi-purpose product is perfect for distributors and end-users alike. There is no need to use different papers and profiles for different applications. It is still the only 'hybrid' paper that can be used successfully for both hard & soft substrates.

Size : 1.1 m x 84 m (110 cm x 840 cm)

Paper weight : 110 gsm





beaver paper
& Graphic Media, Inc.

TexPrint[®]DT_{XP}light

TP-DTL TexPrint[®] DT Light Sublimation Papers for EPSON Printers

Size : A4 (110 sheets / pack)

Paper weight : 105 gsm



TexPrint[®]DT_Rheavy

TP-DTH-A4 / TP-DTH-A3 TexPrint[®] DT Heavy Sublimation Papers for SAWGRASS Printers

Size : A4 & A3 (110 sheets / pack)

Paper weight : 120 gsm





INCREDIBLE SHORT TRANSFER TIME
10
SECONDS



- ▶ Short Transfer Time
- ▶ Incredible Soft Texture
- ▶ No more paper jams
- ▶ Works with most laser printer & color laser copiers

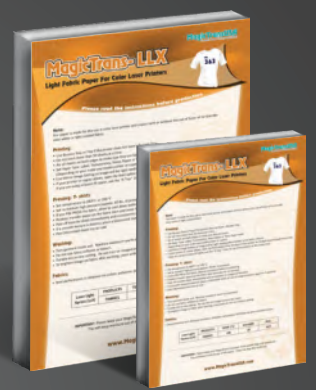

MagicTrans-LLX
Light Fabric Paper For Color Laser Printers

363-A3 (A3 Size) / 363 (A4 Size)
LIGHT FABRIC TRANSFER PAPER FOR LASER PRINTERS

Best Performance is obtained on Cotton, Polyester, Poly/Cotton, 50/50 blends and untreated canvas.

 **Application & Transfer Instruction**

Product : Laser Light Xpress	Pressure : Maximum Pressure
Temperature : 375°F / 190°C.	Removal : Quickly Peel
Press Time : 10 seconds.	Print Mirror : Yes



INCREDIBLE SHORT TRANSFER TIME
20
SECONDS



MagicTrans-Jet Light
Light Fabric Paper For Inkjet Printers

349 (A3 Size) / 350 (A4 Size)
LIGHT FABRIC TRANSFER PAPER FOR INKJET PRINTERS

Transfer to materials such as : T-shirts, Polo Shirts, Poly Cottons/Blends.

 **Application & Transfer Instruction**

Product : MagicTransJet-Light	Pressure : Maximum Pressure
Temperature : 350°F / 175°C.	Removal : Quickly Peel
Press Time : 20 seconds.	Print Mirror : Yes



MagicTrans-CLP Dark

Dark Fabric Paper For Laserjet Printers

362 (A3 Size) / 351 (A4 Size)

DARK FABRIC TRANSFER PAPER FOR LASER PRINTERS

Transfer to materials such as : Dark Coloured Fabric, 100% Cotton, 100% polyester, Poly/Cotton Blends, Polyester knits, Poly / Foam & Cotton Caps, Satin Materials.



Application & Transfer Instruction

Product : MagicTransCLP-Dark	Pressure : Maximum Pressure
Temperature : 400°F / 205°C.	Removal : Quickly Peel
Press Time : 30 seconds.	Print Mirror : Yes



MagicTrans-Jet Dark

Dark Fabric Paper For Inkjet Printers

355 (A3 Size) / 356 (A4 Size)

DARK FABRIC TRANSFER PAPER FOR INKJET PRINTERS

Transfer to materials such as : T-shirts, Polo Shirts, Poly Cottons/Blends.



Application & Transfer Instruction

Product : MagicTransJet-Dark	Pressure : Maximum Pressure
Temperature : 350°F / 175°C.	Removal : Cool Peel
Press Time : 30 seconds.	Print Mirror : Yes



FREE *Style* DARK

TRANSFER PAPER

FS-01

FREESTYLE DARK

A self-weeding laser transfer paper and works well on various garments like cotton, cotton blends, 100% polyester and leather.

Application & Transfer Instruction

Printable Film : Matte Side	White toner : Opacity -3
Paper Mode : Transparency	Pressure : Medium (2 - 3 bar)
Temperature : 150°C - 160°C	Print Mirror : Yes





360 (A4 Size)

DECAL PAPER FOR LASERJET PRINTERS

1 > Print with laser printer

2 > Cut out the decals

3 > Place the decal in a bowl of warm water for about 30 - 45 seconds (until the decal slide on back paper)

4 > Position the backing paper on your item.

5 > Slide decal off on to the item

6 > Allow to dry fully before handling. (Speed up drying by a blow dryer)

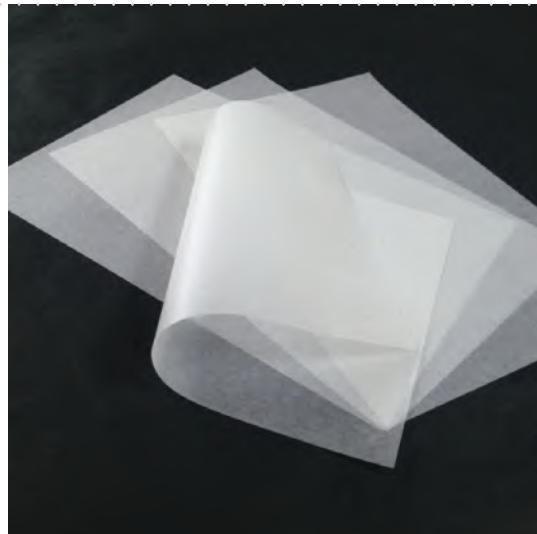

HTP-03 (A3 Size) / HTP-04 (A4 Size)

BUTTER PAPER

Protect the upper platen of your heat press.
Leave a soft and smooth finish on heat transfer materials.

BEST CHOICE FOR COTTON FABRICS

- ▶ Virtually no dry time – cut immediately
- ▶ Easy weeding
- ▶ Quick masking
- ▶ 1-step, fast heat-application and cold peel



STAHL'S ID *direct*[™]
IDENTITY FOR TEXTILES

CAD-COLOR® *Express Print*

Stahls' Express Print is perfect for creating full-color transfers with your solvent or eco-solvent based printer for a variety of applications on cotton and cotton-poly blends.

HTM-EP

PRINTABLE HEAT TRANSFER MATERIAL

Available in 3 Sizes (100cm, 75cm, 50cm)



Application & Transfer Instruction

Product : Express Print	Pressure : Medium Pressure
Temperature : 320°F / 160°C.	Removal : Cold Peel
Press Time : 15 - 20 seconds.	Print Mirror : No

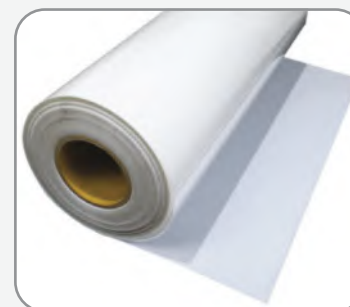

HTM-AT

APPLICATION TAPE FOR HEAT TRANSFER MATERIAL

Roll Size : 50 cm x 50 meters roll

- ▶ Shimmering stretchability.
- ▶ Lightweight, Soft hand
- ▶ Gloss finish
- ▶ Low application temperature
- safe for sensitive materials



STAHL'S ID direct™
IDENTITY FOR TEXTILES

Printable
HEAT TRANSFER MATERIAL

FoilTEK™ 

HTM-FT

PRINTABLE HEAT TRANSFER MATERIAL

Roll : 50 cm width (22.5m length)

Printable, polyurethane film with patented StiX2 adhesive sticks to anything. First printable metallic with 4-way stretch and rebound. Lightweight, flexible and soft hand. Fast, flexible heat application eliminates heat press marks.

Transfer to materials such as :

100% cotton, 100% polyester, Poly/cotton blends, Spandex blends, Most Nylons



Application & Transfer Instruction

Product : Express Print	Pressure : Medium Pressure
Temperature : 320°F / 160°C.	Removal : Cold Peel
Press Time : 15 - 20 seconds.	Print Mirror : No



Get Creative with Quality Materials

Take your first step to success by choosing the right heat transfer vinyl. Whether you're decorating for athletics, fashion, or corporate apparel, we have a finish and material to help you get the job done.



Thin and Soft hand makes it great for personalizing

FASHION

HEAT TRANSFER VINYL



HTM-MT

FASHION FILM - METALLIC II HEAT TRANSFER VINYL

Add a higher-perceived value to designs with Metallic Vinyl. This vinyl gives the look of mirror finish with an incredibly soft feel.

Material/Fabric Compatibility : 100% Cotton, 100% Polyester, Cotton/Poly Blends.



Available Colors :



Application & Transfer Instruction

Product : Fashion-FILM®
Press Time : 10 - 12 seconds.
Temperature : 290-302°F
Temperature : 290-302°F
Removal : Warm Peel



STAHL'S *ID direct*[™]
 IDENTITY FOR TEXTILES

Staying safe
 and looking good.

REFLECT

HEAT TRANSFER VINYL



HTM-RF-SL

**REFLECTIVE II
 HEAT TRANSFER VINYL**

Excellent for use as an accent on sports uniforms and accessories, this reflective vinyl makes designs stand out. Use it for added visibility on backpacks, jackets, fashion apparel, and more.

Material/Fabric Compatibility : 100% Cotton, 100% Polyester,
 100% Preshrunk Cotton, Cotton/Poly Blends



Available Colors :



 **Application & Transfer Instruction**

Product : Reflective II
Press Time : 10 - 12 seconds.
Temperature : 290-302°F
Pressure : Medium Pressure
Removal : Cold Peel



Bling look that makes their apparel stand out.

GLITTER

HEAT TRANSFER VINYL



HTM-GL

GLITTER METALLIC HEAT TRANSFER VINYL

Create brilliant designs that sparkle and shine! This heat transfer glitter vinyl stands out on the playground, on the sidelines, on campus, or anywhere else you'll find fan wear, cheer apparel, and fashion garments.

Material/Fabric Compatibility : 100% Cotton, 100% Polyester, 100% Preshrunk Cotton, Cotton/Poly Blends



Available Colors :



Application & Transfer Instruction

Product : Glitter Flake™
Press Time : 10 - 12 seconds.
Temperature : 290-302°F
Pressure : Medium Pressure
Removal : Hot Peel

Bright and vivid with this suede-like flocked material

SOFT
HEAT TRANSFER VINYL

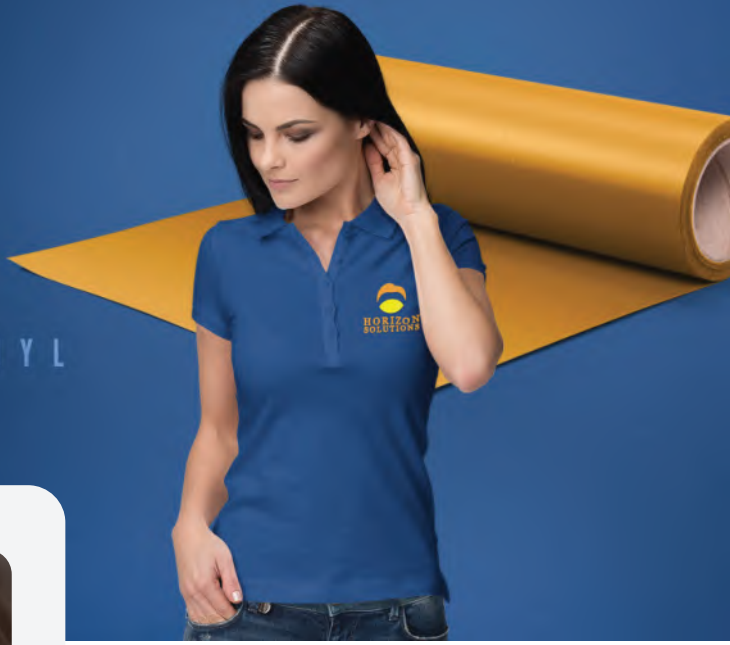

HTM-FV
FLOCK
HEAT TRANSFER VINYL

This flocked vinyl is made with high-density, high-quality fibers making colors more vibrant and long-lasting. This vinyl is the perfect alternative to embroidery.

Material/Fabric Compatibility : 100% Cotton, 100% Polyester, Cotton/Poly Blends

 **Application & Transfer Instruction**

- Product : Flock II
- Press Time : 15 - 20 seconds.
- Temperature : 330°F
- Pressure : Medium Pressure
- Removal : Cold Peel



Available Colors :

Camel Beige	Yellow	Pink
Royal Blue	White	Black
Green	Bright Red	



Best Value Material for Lightweight Garments

LIGHT
HEAT TRANSFER VINYL



HTM-SF

SPORTS FILM LITE HEAT TRANSFER VINYL

Semi-Gloss sports film material, trendy and a perfect material for sport jerseys; Easy to weed and easy to heat applying.

Material/Fabric Compatibility : 100% Cotton, 100% Polyester, Nylons, Cotton/Poly Blends, Spandex Blends.



Available Colors :



Application & Transfer Instruction

Product : SportFilm Lite™
Press Time : 10 - 12 seconds.
Temperature : 290-302°F
Pressure : Medium Pressure
Removal : Warm Peel

Thin and Soft hand makes it great for personalizing

NEON

HEAT TRANSFER VINYL

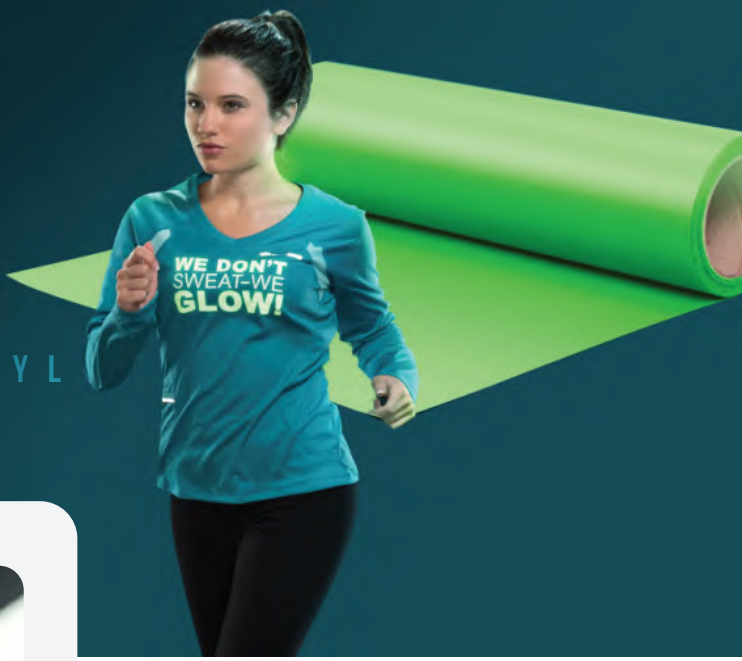

HTM-SF-NEON

SPORTS FILM LITE NEON HEAT TRANSFER VINYL

Highlighten your Logos ang give more attraction to the design by our Neon colours transfer vinyls.

Material/Fabric Compatibility : 100% Cotton, 100% Polyester, Cotton/Poly Blends, Spandex Blends.



Available Colors :



Application & Transfer Instruction

- Product : SportFilm Lite™
- Press Time : 15 - 20 seconds.
- Temperature : 290-302°F
- Pressure : Medium Pressure
- Removal : Warm Peel

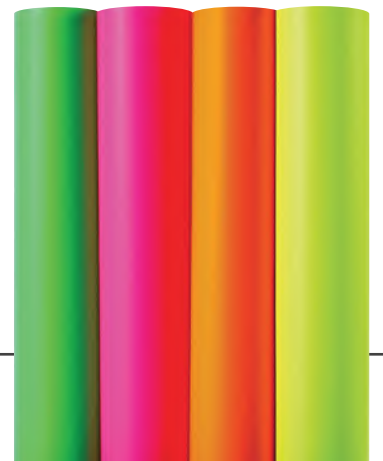

Gives apparel the softest stretchiest feel and the trendy metallic look your customers want.

METALLIC

HEAT TRANSFER VINYL



HTM-SF

SPORTS FILM LITE HEAT TRANSFER VINYL

Foil-like finish with a soft feel. Add a higher perceived value to designs with Metallic Vinyl. Gives the look of foil with an incredibly soft feel.

Material/Fabric Compatibility : 100% Cotton, 100% Polyester, Cotton/Poly Blends



Available Colors :



Application & Transfer Instruction

Product : SportFilm Lite™

Press Time : 10 - 12 seconds.

Temperature : 290-302°F

Pressure : Medium Pressure

Removal : Warm Peel

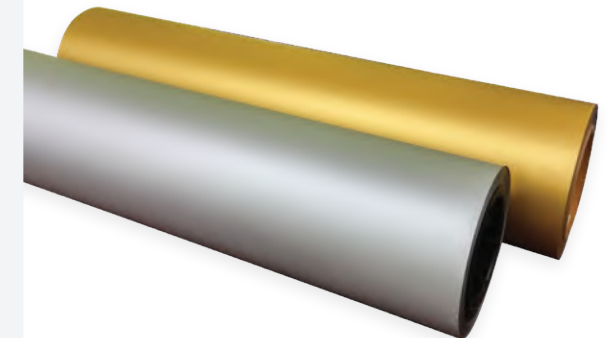

PUFF

HEAT TRANSFER VINYL

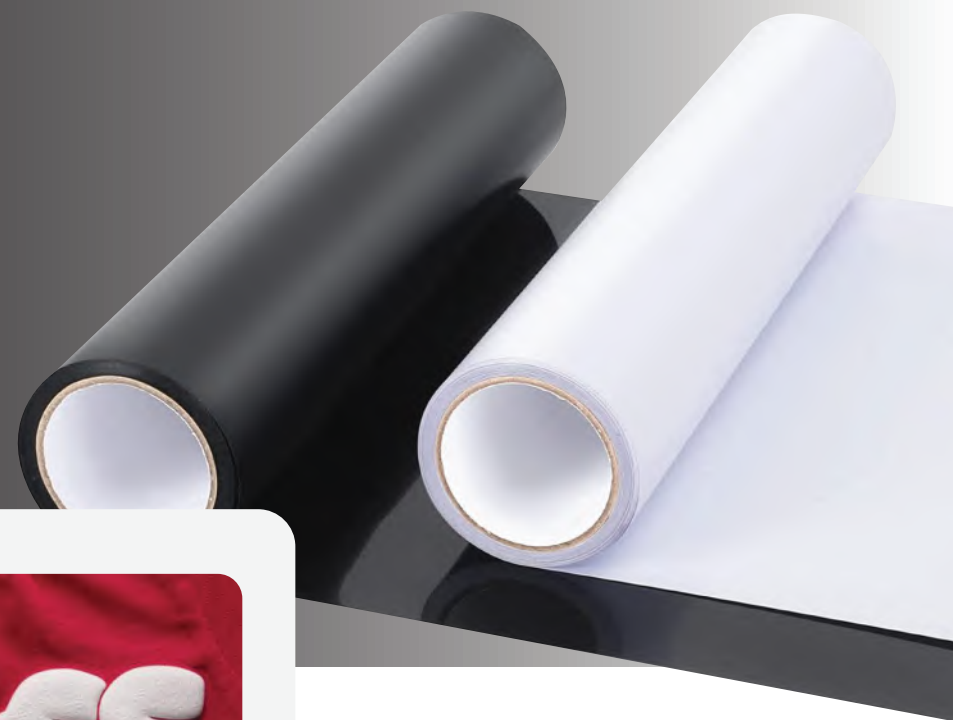

HTM-PF

3D PUFF HEAT TRANSFER VINYL

Easy to create – as the thin PU film expands under a single press to create your original text/design in 3D, available in 2 colors. A clear, light adhesive backing enables fine cutting design and aids registration.

Material/Fabric Compatibility : Suitable for cotton, polyester, mixtures of polyester/cotton, and polyester/acrylic or similar textiles.



Available Colors :

White

Black



Application & Transfer Instruction

Product : 3D Puff

Press Time : 8 - 10 seconds.

Temperature : 150 - 160°C

Pressure : Medium Pressure

Removal : Warm Peel





Sublimation Solutions

Dye sublimation is a digital printing technology that enables the reproduction of colourful images on common everyday items, including clothing and novelties.

You create an image on your computer, print it onto a special transfer paper using sublimation inks, and then apply the paper with the image to the item to be decorated.

We offer a large collection of Blank Products that you can use for your Sublimation Projects.

Sublimation Printables

Drinkwares



147-D

**11 oz - Glossy Finish
White Sublimation Mug**

Dimensions : 95 x 80 mm | 325 ml
1 Pack : 36 pcs. | G.W : 13.2 kg



148

**White Glossy Finish
Sublimation Mug**

Dimensions : 85 x 115 mm | 440 ml
1 Pack : 36 pcs.



149

20 oz - White Ceramic Beer Mug

Come with easy to hold handle and are made of ceramic material. They can be the center of attraction at any party or in a restaurant.
Product Size : 78 x 160 mm. Capacity : 590 ml

White mug is the most popular choice among products made for personalization. Coated with Orca 2 for deeper solid colours without smudging, Dishwasher proof. whiter than ordinary mug. These features lead to the perfect results of the image transfer.

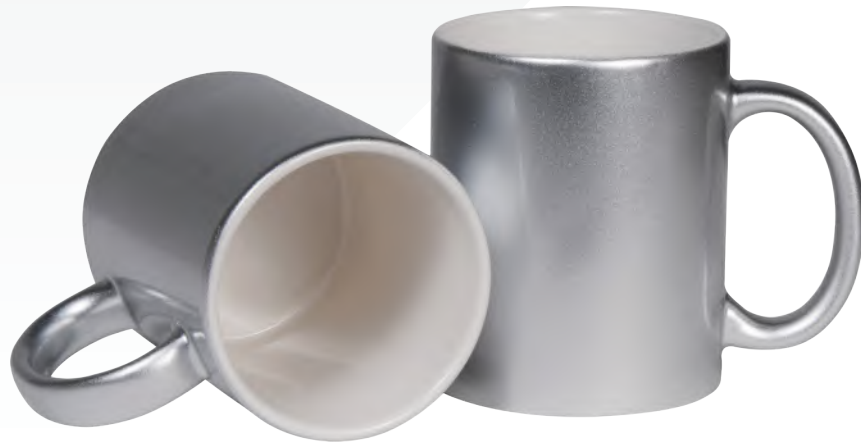

175-S

11 oz - Silver Sublimation Mug

Dimensions : 98 x 80 mm | 325 ml | 1 Pack : 36 pcs



175-G

11 oz - Gold Sublimation Mug

Dimensions : 98 x 80 mm | 325 ml | 1 Pack : 36 pcs



172

11 oz - Black Sublimation Mug with Printable Area

Black background makes the colors of the imprinted image even more vibrant. Dimensions : 80 x 98 mm | 325 ml



191

Couple Mug with Heart-shaped handle

Dimensions : 98 x 80 mm | 325 ml | 1 Pack : 18 pcs
White mug with glossy finish, Delivered in set of two mugs. Perfect gift for couples in love.



146N

White Sublimation Mug with Silicone Cap & Base

Ceramic mug with a heart shaped handle & matching color of silicone cap to avoid leaks & non-slip silicone base.
 Dimensions : 125 x 85 mm

Just pour hot beverages to reveal your full color designs.



167-BK-M

11 oz Color Changing Mug (Semi-Matte Black Finish)

Our color changing mugs look simple enough at first glance. But pouring any hot drink into the heat sensitive glossy black ceramic mug reveals a special surprise. Product Size : 80 x 105 mm | Capacity : 325 ml



GR BK BR Y P BL R OR

170

11 oz Two Tone Ceramic Mug with Spoon

White mug with a colorful parts: interior, handle and spoon.
 Dimensions : 80 x 102 mm | Capacity : 325 ml



BK R BL GR

168

11 oz Two Tone Ceramic Mug with Spoon

White Ceramic Mug with coloured handle & inside
 Dimensions : 80 x 98 mm | Capacity : 325 ml



169

10 oz Curve Edges White Glossy Sublimation Ceramic Mug

Product Size : 75 x 105 mm
Capacity : 295 ml



155

10 oz White Glossy Finish Sublimation Ceramic Mug

Product Size : 70 x 105 mm
Capacity : 295 ml



182

1.5 oz Short Glass

Conical shape glass with a white printable surface and elegant golden rim.
Product Size : 45 x 60 mm. Capacity : 44 ml



180

4 oz Ceramic Saucer Tea Cup

Set of white glossy finish ceramic cup, saucer and a spoon. Dimensions : 50 x 80 mm. Capacity : 120 ml
1 pack : 36 pcs. GW : 13 kg



185

5 oz Ceramic Saucer Tea Cup

White glossy finish ceramic cup & saucer
Product Size : 60 x 60 mm. Capacity : 147 ml
1 pack : 48 pcs. GW : 10.5 kg



154

6 oz Ceramic Tea Cup

White glossy finish ceramic cup.
Product Size : 80 x 50 mm. Capacity : 180 ml
1 pack : 48 pcs. GW : 12 kg



139

15 oz Stainless Steel Bottle

Dimensions : 80 x 105 mm
1 Box : 60 pcs. | Capacity : 440 ml



144

17 oz Stainless Steel Bottle

Dimensions : 70 x 265 mm
1 Box : 50 pcs. | Capacity : 500 ml



TM-013

Stainless Steel Flask with Bamboo Lid

Double wall stainless steel insulating vacuum flask with lid in bamboo and carry handle.
Dimensions : 70 x 255 mm | Capacity: 600 ml.

Sublimation Printables

Ceramic Tiles



174

Ceramic Tiles

Size : 20 x 30 cm | 1 Pack : 24 pcs.



166

Ceramic Tiles

Size : 20 x 25 cm | 1 Pack : 36 pcs.



161

Ceramic Tiles

Size : 20 x 20 cm | 1 Pack : 36 pcs.



165

Ceramic Tiles

Size : 5 x 5 cm
1 Pack : 200 pcs.



163

Ceramic Tiles

Size : 10.8 x 10.8 cm
1 Pack : 48 pcs.



162

Ceramic Tiles

Size : 15 x 15 cm
1 Pack : 36 pcs.



164

Ceramic Tiles

Size : 15 x 20 cm
1 Pack : 36 pcs.



162-F

Wood Frame

Size : 19.3 x 19.3 cm
Inside Tile Size :
15 x 15 cm

Sublimation Printables

Promotional Puzzles

A Great way to sharpen the mind while promoting the logo. The particular parts of the jigsaw are precisely cut and they match each other very well. There is wide choice of models.



PP-02

60 pcs - Sublimation Puzzles

Hardboard material. Size : 246 x 170 mm



PP-03

30 pcs - Sublimation Puzzles

Hardboard material. Size : 246 x 170 mm



PP-04

75 pcs - Sublimation Puzzles

Cardboard material. Size : 190 x 190 mm



PP-05

80 pcs - Sublimation Puzzles

Cardboard material. Size : 200 x 145 mm

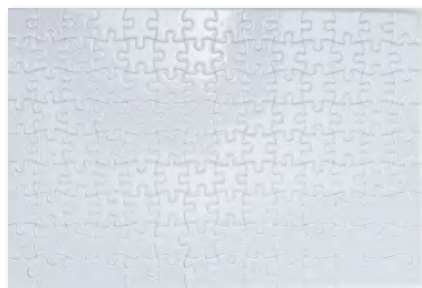

PP-06

126 pcs - Sublimation Puzzles

Cardboard material. Size : 270 x 180 mm



PP-09

36 pcs - Sublimation Puzzles

Cardboard material. Size : 270 x 180 mm



PP-10

252 pcs - Sublimation Puzzles

Cardboard material. Size : 342 x 254 mm

Sublimation Printables

Photo Rocks



201
Sublimation Rock Photo

Dimensions : 200 x 200 mm
 1 Pack : 20 pcs. | G.W. 22 kg



205
Sublimation Rock Photo

Dimensions : 200 x 200 mm
 1 Pack : 20 pcs. | G.W. 24 kg



202
Sublimation Rock Photo

Dimensions : 200 x 200 mm
 1 Pack : 20 pcs. | G.W. 24 kg



203
Sublimation Rock Photo

Dimensions : 120 x 200 mm
 1 Pack : 32 pcs. | G.W. 16 kg



204
Sublimation Rock Photo with wooden frame

Dimensions : 180 x 260 mm
 1 Pack : 10 pcs. | G.W. 15 kg

Sublimation Printables

Photo Crystal



206-F

Photo Crystal

Product Size : 150 x 100 mm
1 Pack : 14 pcs.



210-F

Photo Crystal

Product Size : 150 x 165 mm
1 Pack : 14 pcs.



226-F

Photo Crystal

Product Size : 80 x 100 mm
1 Pack : 36 pcs.



214-F

Photo Crystal

Product Size : 130 x 210 mm
1 Pack : 14 pcs.



215-F

Photo Crystal

Product Size : 90 x 150 mm
1 Pack : 14 pcs.



216-F

Photo Crystal

Size : 130 x 200 mm
1 Pack : 14 pcs.



217-F

Photo Crystal

Size : 100 x 190 mm
1 Pack : 14 pcs.



218-F

Photo Crystal

Size : 100 x 190 mm
1 Pack : 14 pcs.



222-F / 221-F

Photo Crystal

Product Size : 180 x 230mm / 130 x 180mm
1 Pack : 20 pcs.



266-A / 266-B

Rectangular Mousepad

266-A has a 5mm Thickness
 266-B has a 3mm Thickness
 Product Size : 20 x 23 cm



265

Heart-shaped Mousepad

Thickness : 3 mm
 Product Size : 20 cm



263

Round Mousepad

Thickness : 3 mm
 Product Size : 20 cm

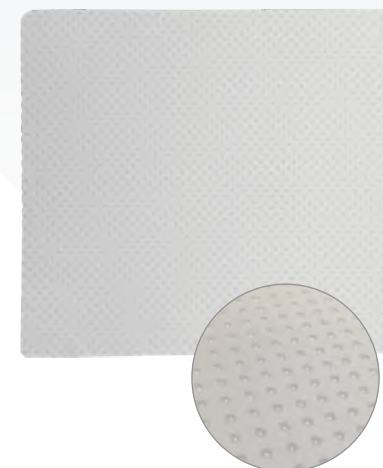

262

Non-Slip White Fabric Mousepad

Soft polyester material
 Product Size : 19.7 x 18 cm



213-F

Crystal Keychains

Glass material with white area for Sublimation printing.
 Thickness : 10 mm, Printable Area : 22 x 32 mm



242
 Size : 150 mm
 1 Pack : 100 pcs.



244
 Size : 100 mm
 1 Pack : 100 pcs.



247
 Size : 75 mm
 1 Pack : 100 pcs.



250
 Size : 80 x 60 mm
 1 Pack : 100 pcs.



245
 Size : 90 mm
 1 Pack : 100 pcs.



248
 Size : 80 mm
 1 Pack : 100 pcs.



224

Hardboard Tea Coaster

Dimensions : 10 x 10 cm
Square shaped with rounded corners.
Hardboard material
1 Pack : 120 pcs.

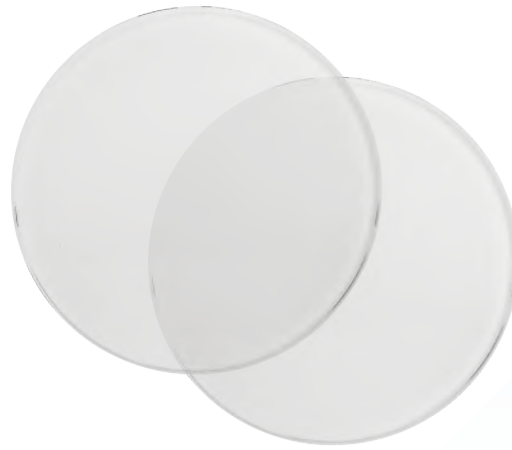

220-F

Round Tea Coaster

Dimensions : 10 x 10 cm
Round shaped glass with
white printable area for Sublimation
1 Pack : 120 pcs.



219-F

Square Tea Coaster

Dimensions : 10 x 10 cm
Square shaped glass with
white printable area for Sublimation
1 Pack : 120 pcs.



707

Sublimation Cushions

Dimensions : 35.5 x 40.5 cm
Printing area : 20 x 20 cm
Polyester & Cotton material



183

Sublimation Tie

Our sublimation white tie is made of polyester, a soft and comfortable material. Relatively narrow tie that is fashionable & looks good with full color printing.



NW-SUB-A5

A5 Size - Vertical Sublimation Bag

Dimensions : 19 x 24 x 12 cm
White non-woven bag for full color sublimation.

NW-SUB-A4H

A4 Size - Horizontal Sublimation Bag

Dimensions : 32.5 x 25 x 12 cm
White non-woven bag for full color sublimation.



SC-03

Sublimation Scarf

White Blank Scarf with fringes on both ends.
Material : Polyester



NW-SUB

Sublimation Bag

Dimensions : 37 x 39 cm
White non-woven bag for full color sublimation.



NW-SUB-6V

Sublimation Bag

Dimensions : 30 x 38 x 12 cm
White non-woven bag for full color sublimation.

Coated Aluminum Name Badges

Ideal Badges for Full Color Sublimation Printing
Size : 65 x 18 mm (Minimum of 50pcs. per design)





Lens Cover Rectangular Name Badges for Sublimation



INB-08

Aluminum Name Badge

Product Full Size : 80 x 40mm, Backside with Pin or Magnet.

Available in 3 different colours.

Gold Finish, Silver Finish, Glossy White



Lens Cover Oval Shaped Name Badges for Sublimation



INB-09

Aluminum Name Badge

Product Full Size : 68 x 45mm, Backside with Pin or Magnet.
Available in 3 different colours.
Gold Finish, Silver Finish, Glossy White



Lens Cover Rectangular Name Badges for Sublimation



INB-03

Aluminum Name Badge

Product Full Size : 80 x 30mm, Backside with Pin or Magnet.
Available in 3 different colours.
Gold Finish, Silver Finish, Glossy White



Reusable Window Insert Name Badges for Sublimation



INB-05

Aluminum Reusable Window Insert Name Badge

Full Size : 73 x 38 mm, Window Size : 63 x 12 mm
 Available in 3 different colours.
 Gold Finish, Silver Finish, Glossy White



Reusable Name Badge Aluminum Plate for Sublimation

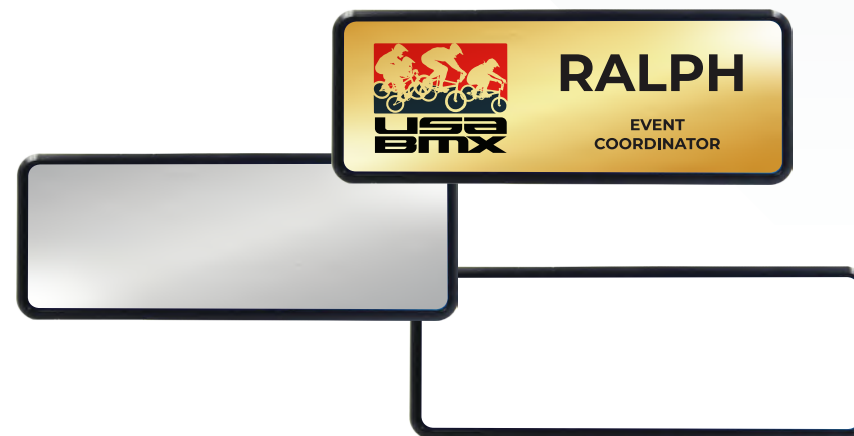

INB-12

Reusable Name Badges

Product Full Size : 80 x 30mm, Plate Size : 76 x 26 mm
 Available in 3 different colours.
 Gold Finish, Silver Finish, Glossy White



Silicone card holder with sticky screen cleaner.



MPP-01

Card Holder with Screen cleaner

Available in White or Black color.

Double Hook Lanyards

A great lanyard for exhibits, seminars & other corporate events.



LN-007-W

White Lanyard with Double hook

20mm Soft polyester material for your full colour printing.

Sublimation Lanyards

The custom printed lanyards are your perfect choice to display your Design or Logo in full colour. They are printed on smooth polyester material through digital dye sublimation on one or two side printing.



20mm Lanyard with Buckle



LN-002-CW

Clip Type
2 x 90 cm

LN-002-HW

Hook Type
2 x 90 cm

20mm Lanyard w/Safety Hook



LN-004-CW

Clip & Mobile Holder
2 x 90 cm

LN-004-HW

Hook & Mobile Holder
2 x 90 cm

15mm Standard Lanyard



LN-005-CW

Clip & Mobile Holder
1.5 x 90 cm



WSH

Silver / Bronze Wall Sign Holder

A Larger metal slide plate for your office, buildings, etc. that is affixed to a wall or other smooth surface for intentional message and informational purposes. Product Size : 25.5 x 10.5 cm



WSH

Silver / Bronze Wall Sign Holder

A Larger metal slide plate for your office, buildings, etc. that is affixed to a wall or other smooth surface for intentional message and informational purposes. Product Size : 25.5 x 5.5 cm





DSH-11

Silver Desk Sign Holder

Metal slide plate for your desk.
Size : 25.5 x 5.5 cm



DSH-12

Bronze Desk Sign Holder

Metal slide plate for your desk.
Size : 25.5 x 5.5 cm



DSH-13

Black Desk Sign Holder

Metal slide plate for your desk.
Size : 25.5 x 5.5 cm

Sublimation Aluminum Sheets

0.75 mm Thickness - Size : 30 x 60 cm

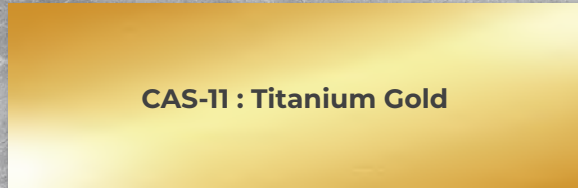

CAS-11 : Titanium Gold

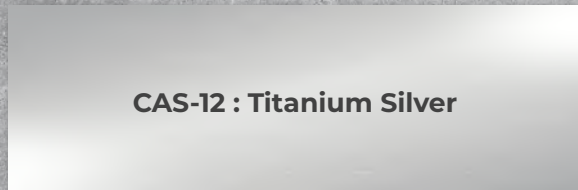

CAS-12 : Titanium Silver

Photo HD Sublimation Aluminum Sheets

1.15 mm Thickness - Size : 60 x 120 cm



CAS-HD-01 : Glossy White



CAS-HD-02 : Glossy Silver

UV Printing Aluminum Sheets

1 mm Thickness - Size : 60 x 122 cm



CAS-UV-01
Gloss White



CAS-UV-02
Gold Matt



CAS-UV-03
Silver Matt

Laserable Sheets

0.6 mm Thickness - Size : 30 x 60 cm



665-BKG
Glossy Black / Gold
Aluminum Sheet



665-BKS
Glossy Black / Silver
Aluminum Sheet



663-BK
Black / Gold
Brass Sheet
Made in USA

Hardboard Sublimation Supplies



Hardboard Keytags
Thickness : 3 mm



Hardboard Bag Tags
Thickness : 3 mm



Keepsake & Ornaments
Thickness : 6 mm



Award & Plaques
Thickness : 15 mm



Clocks
Thickness : 3 mm



Photo Panel & Picture Frames
Thickness : 6 mm

High-Quality Coated Aluminum Sheets

0.6 mm Thickness Sheets for Sublimation Printing

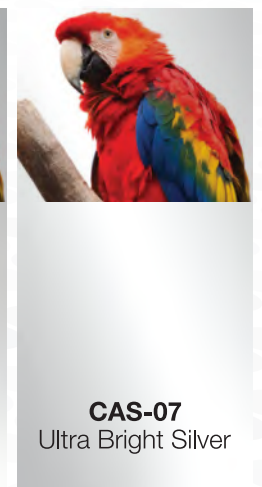
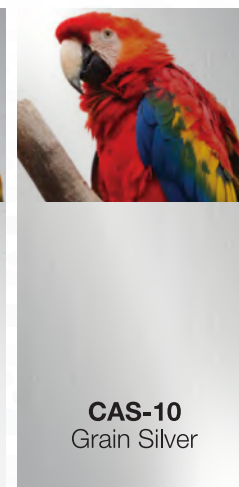
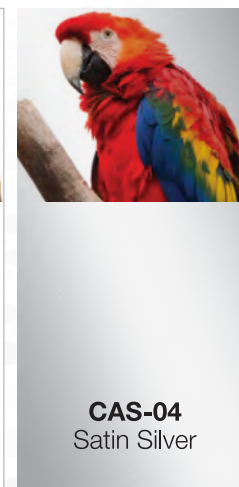
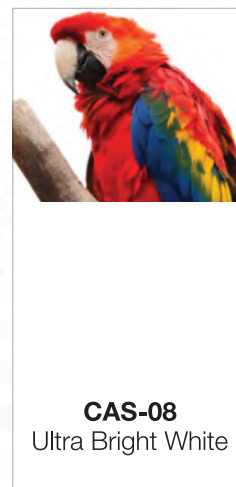
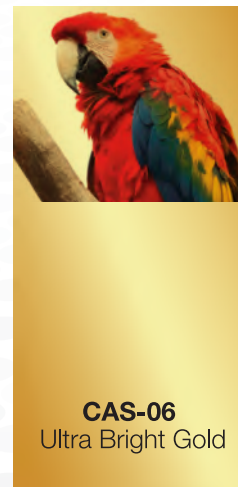
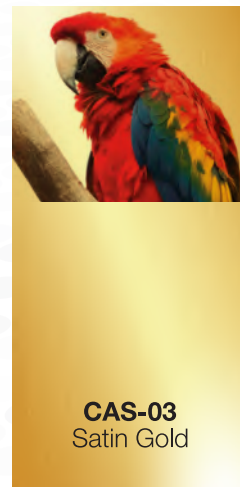
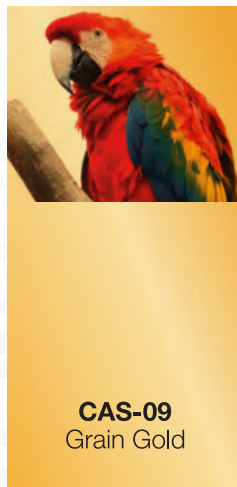
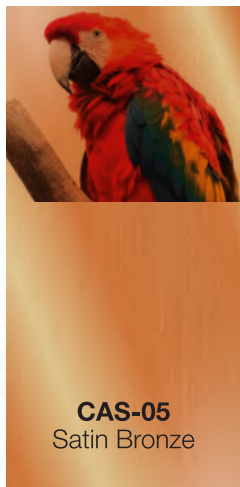
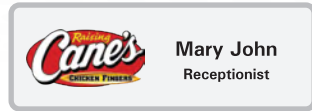

CAS-05
Satin Bronze

CAS-09
Grain Gold

CAS-03
Satin Gold

CAS-06
Ultra Bright Gold

CAS-08
Ultra Bright White

CAS-04
Satin Silver

CAS-10
Grain Silver

CAS-07
Ultra Bright Silver

T-SHIRT & CAP PRINTING Business Package 1



1 A4 Size Laser Printer

Printing Method	Digital 4 LED Full-color Electrophotographic
Printing Resolution	600 x 600 dpi, 600 x 600 dpi (4 levels) 600 x 1200 dpi, Physical dot pitch: 600 dpi
Print Speed	A4 34 ppm color, 36 ppm mono
Paper Size	A4



2 2 in 1 : Heat Press

Flat Press Dimensions : 25.5 x 20.5 cm
Cap Press Dimensions : 9 x 16.5 cm
Max Temperature : 221°C / 430°F.
Power Rating : 220 Volt, 1800 Watts

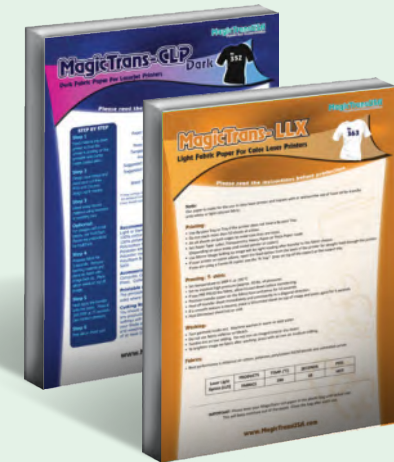

3 Transfer Papers

363-A4 (A4 Size)
LIGHT FABRIC TRANSFER PAPER

351 (A4 Size)
DARK FABRIC TRANSFER PAPER

Transfer to materials such as : 100% Cotton, 100% polyester, Poly/Cotton Blends, Polyester knits, Poly / Foam & Cotton Caps, Satin Materials.

START YOUR OWN BUSINESS NOW!

T-SHIRT PRINTING

Business Package 2



1

A4 Size Inkjet Printer

- Ultra-low-cost photos: Included inks can print up to 1,900 quality 10x15cm photos
- Epson-quality, reliable results: Micro Piezo technology and Epson genuine ink
- Boost productivity: Print a 10x15cm photo in as little as 12 seconds
- User friendly: Hassle-free with simple set-up and maintenance
- Flexible: Wi-Fi connectivity and easy mobile printing

2

Optional Heat Press

OPTION 1 : HPM-01

Press Dimensions : 15" x 15" (38 x 38 cm)
Product Dimensions : 66 x 40 x 83 cm

OPTION 2 : HPM-02

Press Dimensions : 16" x 20" (40 x 50 cm)
Product Dimensions : 80 x 42 x 93 cm

3

Transfer Papers

350 (A4 Size)

LIGHT FABRIC TRANSFER PAPER

356 (A4 Size)

DARK FABRIC TRANSFER PAPER

Transfer to materials such as : T-shirts, Polo Shirts, Poly Cottons/Blends.

START YOUR OWN BUSINESS NOW!

T-SHIRT & CAP PRINTING

Business Package 3

S
STAHL'S
 Hotronix®



1 A4 Size Laser Printer

Printing Method	Digital 4 LED Full-color Electrophotographic
Printing Resolution	600 x 600 dpi, 600 x 600 dpi (4 levels) 600 x 1200 dpi, Physical dot pitch: 600 dpi
Print Speed	A4 34 ppm color, 36 ppm mono
Paper Size	A4

2 STAHL'S Heat Press

STH-STXC
 Press Dimensions : 6 " x 3.5 " Platens (15 x 9 cm)
 Product Dimensions : 21" x 10" x 18" (53 x 25.4 x 46 cm)

STH-STX16
 Press Dimensions : 16 " x 16 " Platens (40 x 40 cm)
 Product Dimensions : 28" x 17" x 17" (71 x 43 x 43 cm)

3 Transfer Papers

363-A4 (A4 Size)
LIGHT FABRIC TRANSFER PAPER

351 (A4 Size)
DARK FABRIC TRANSFER PAPER
 Transfer to materials such as : 100% Cotton, 100% polyester,
 Poly/Cotton Blends, Polyester knits, Poly / Foam & Cotton Caps,
 Satin Materials.

START YOUR OWN BUSINESS NOW!



T-SHIRT & CAP PRINTING Business Package 4



1 STAHL'S Cap Press

Press Dimensions : 6 " x 3.5 " Platens (15 x 9 cm)

Temperature Range : 205° - 420°F.

Electrical Options : 120 V; 4 amps; 500 W / 240 V; 2 amps; 500 W

Product Dimensions : 21" x 10" x 18" (53 x 25.4 x 46 cm)

Actual Weight : 30 lbs (13.6 kg)



2 40 x 50 Heat Press

Press Dimensions : 16 " x 20 " Platens (40 x 50 cm)

Temperature Range : 205° - 420°F.

Electrical Options : 120 V; 15 amps; 1800 W / 240 V; 7.5 amps; 1800 W

Product Dimensions : 29" x 17" x 17" (73 x 43 x 43 cm)

Actual Weight : 87 lbs (40 kg)



3 Transfer Papers

363-A4 (A4 Size)

LIGHT FABRIC TRANSFER PAPER

351 (A4 Size)

DARK FABRIC TRANSFER PAPER

Transfer to materials such as : 100% Cotton, 100% polyester, Poly/Cotton Blends, Polyester knits, Poly / Foam & Cotton Caps, Satin Materials.

START YOUR OWN BUSINESS NOW!



Scan for Flipbook

HEATTRANSFER.COM
Printing Machines and Supplies Division of Magic Trading Co. LLC.

MTC[®]
MAGIC TRADING Co.

Heattransfer Machinery Showroom , Beside Sharjah City Center
Al Wahda Road, , Sharjah , United Arab Emirates
Tel. : +971 6 533 2236
sales@heattransfer.com / sales1@heattransfer.com
+971 50 398 3900 / +971 56 726 4477
www.heattransfer.com / www.mtc.ae